

LTC 8600, LTC 8800 Series



Security Systems

EN

Instruction Manual
Allegiant Microprocessor-
based Video Switcher/Control Systems
CPU Firmware
Version 10.0

BOSCH

Table of Contents

1	Safety	1
2	Unpacking	9
2.1	Parts List	9
3	Service	10
4	Description	11
5	Allegiant Feature Summary Table	13
6	System Components	15
6.1	LTC 8601 Series Systems	15
6.2	LTC 8800 Series Systems	15
7	System Accessory Components	17
7.1	LTC 8540/00 Alarm Interface Unit	17
7.2	LTC 8568 and LTC 8768 Signal Distribution Units	17
7.3	IntuiKey Series KBD-Universal Keyboard	17
7.4	KBD-Rack Keyboard Mounting Kit	17
7.5	LTC 8555 Series Keyboards	18
7.6	LTC 8558/00 Keyboard Extension Cable	18
7.7	LTC 8557 Series Keyboard Extension Kits	18
7.8	LTC 8560 and LTC 8561 Series Receiver/Driver Units	18
7.9	AutoDome Series	18
7.10	LTC 8569, LTC 8570, LTC 8571, LTC 8572 Series Code Merger Units	19
7.11	LTC 8770 Switcher Follower Series	19
7.12	LTC 8712 Series Console Port Expander Units	19
7.13	LTC 8713 Alarm Port Expander Units	19
7.14	LTC 8714, LTC 8715 Series Keyboard Port Expander Units	19
7.15	LTC 8780 Series Data Converter Units	20
7.16	LTC 8781 Series Data Converter Units	20
7.17	LTC 8016/90 Bilinx™ Data Interface Unit	20
7.18	LTC 8785 Series Code Converters	20
7.19	LTC 8782 Series Code Translator Units	21
7.20	LTC 8808/00 Series Video Interconnect Panel	21
7.21	LTC 8059/00 Master Control Software	21
7.22	LTC 8850/00 Windows Based Graphical User Interface Software	21
7.23	SFT-INTSRV Allegiant Integration Software	21
7.23.1	Integration Server	22
7.23.2	Virtual Allegiant Satellite Application Software	22
7.23.3	Allegiant Satellite SDK	22
7.24	LTC 8506/00 PC-to-Console Port RS-232 Cable	23
7.25	LTC 8508/01 Ribbon-to-BNC Interface Cable	23
7.26	Logging Printer	23

8	Installation Procedure	28
8.1	Main CPU Bay Installation	28
8.2	Video Input Modules.....	28
8.3	Video Output Modules.....	29
8.4	CPU Module.....	29
8.5	Camera and Monitor Video Connections.....	30
8.5.1	LTC 8600 Series and LTC 8800 Series Video Input Connections	30
8.6	Termination Practices.....	31
8.6.1	LTC 8600 Series or LTC 8800 Series Video Input Terminations	32
8.6.2	LTC 8802 Series Monitor Expansion Bay Video Input Connections	32
8.6.3	LTC 8802 Series Monitor Expansion Bay Data Connections	33
8.6.4	Monitor Output Video Connections	33
9	Optional Accessories Installation	34
9.1	General Accessory Installation	34
9.2	Logging Printer Option Installation	34
9.3	Computer Interface Installation.....	34
10	Satellite Configuration Installations	36
10.1	Satellite Site “Trunk Line” Monitor Outputs.....	36
10.2	Main Site “Trunk Line” Video Inputs.....	37
10.3	Control Data Lines in Satellite Systems	37
10.4	Satellite Site Programming Requirements.....	37
10.5	Main Site Programming Requirements	38
10.6	Special Programming for “Cascaded” Satellite System Configurations	40
10.7	Alarm Inputs in Satellite Systems.....	41
11	Feature Selection	42
12	Main Power Connections	43
13	Video Monitor Display	45
13.1	Time/Date.....	45
13.2	Monitor Title/System Status Display	46
13.2.1	System Status Display	46
13.2.2	Locations 1, 2, and 3 - Alarm Indication	46
13.2.3	Location 4 - Monitor Arm Status Indication	46
13.2.4	Location 5 - Camera Arm Status Indication	46
13.2.5	Location 6 - Error Indication	46
13.2.6	Location 7 - Remote Lock Indication	47
13.2.7	Location 8 - Monitor Lock Indication	47
13.2.8	Location 9 - Sequence Type Indication	47
13.2.9	Locations 10 and 11 - Sequence Number	47
13.2.10	Location 12 - Sequence Status Indication	48
13.3	Monitor Title.....	48
13.4	Broadcast Message.....	48
13.5	Program Prompts	48
13.6	Camera Number.....	49
13.7	Camera Title	49
13.8	Video Loss Detection.....	49

14	Factory Default Settings	50
14.1	User Selectable DIP Switch Settings for Main CPU Bay	50
14.1.1	Upper CPU DIP Switch S1	50
14.1.2	Middle CPU DIP Switch S2	51
14.1.3	Lower CPU DIP Switch S3	53
14.2	User Selectable DIP Switch Settings for LTC 8816/00 Data Receiver Modules used in LTC 8802 Series Monitor Expansion Bays	54
14.2.1	Upper Data Receiver DIP Switch S1	54
14.2.2	Middle Data Receiver DIP Switch S2	55
14.2.3	Lower Data Receiver DIP Switch S3	55
15	User Information	56
15.1	User Priority Levels.....	56
15.2	User Priority Access Table	57
16	Alarm Information	58
16.1	General	58
16.2	Basic Alarm Response Mode	58
16.3	Auto Build Alarm Response Mode	58
16.4	Sequence and Display Alarm Response Mode.....	58
16.5	Alarm Activated Pre-position	59
16.6	Sample Alarm Responses	59
16.7	Alarm Relay Response	61
17	Keyboard Operation	62
17.1	General	62
17.2	System Commands.....	62
17.2.1	Keyboard Log-in Procedure	62
17.2.2	Keyboard Log-off Procedure	63
17.3	Switcher Commands	63
17.4	Controlling Camera Movement.....	63
17.4.1	Focus and Iris Lens Control	63
17.4.2	Lock or Unlock Control of a Camera	63
17.4.3	Lock or Unlock Control of a Monitor	64
17.4.4	Recording a Camera Pre-position Scene	64
17.4.5	Recalling a Camera Pre-position Scene	64
17.4.6	Activate/Deactivate Auxiliary Function	64
17.5	Alarm Commands	65
17.5.1	Arm/Disarm Individual Alarms	65
17.5.2	Arm/Disarm All Alarms	66
17.5.3	Arm/Disarm Monitor	66
17.5.4	Alarms Acknowledgement	66
17.6	Sequence Control.....	66
17.6.1	Load/Clear a Sequence	66
17.6.2	Run a Sequence	67
17.6.3	Stop a Running Sequence	67
17.6.4	Controlling Sequence Direction	67
17.7	Sequence Programming	68
17.7.1	Programming a Simple Camera Sequence	68
17.7.2	Programming a SalvoSwitching Camera Sequence	70
18	Keyboard User Functions	71
18.1	General Information	71

19	Maintenance Information	83
19.1	Cleaning the Keyboard	83
19.2	AC Line Voltage Input Selection	83
19.3	AC Line Fuse Replacement	84
19.4	Power Supply Fuse Replacement	84
19.5	Replacement of Memory Backup Batteries.....	84
20	Character ROM Tables for LTC 8600 and LTC 8800	86
21	ERROR MESSAGES	99
22	Troubleshooting Guide	102
22.1	Main Bay Checkout.....	102
22.2	Keyboard Checkout	103
22.3	Video Monitor Display Checkout	103
22.4	Remote Receiver/Driver Functions Inoperative	104
22.5	No Alarm Response	104
22.6	CPU Software Version Numbers	104
23	GLOSSARY OF TERMS	105
Appendix A	Satellite Systems	107
Appendix B	Installation Checklists	114
Appendix C	Quick Reference Cable Interconnections	115
Appendix D	Main Bay Rear Panel Connector Pin-outs	117

1 Safety

Important Safety Instructions

Read, follow, and retain for future reference all of the following safety instructions. Heed all warnings on the unit and in the operating instructions before operating the unit.

1. **Cleaning** - Unplug the unit from the outlet before cleaning. Follow any instructions provided with the unit. Generally, using a dry cloth for cleaning is sufficient, but a moist fluff-free cloth or leather shammy may also be used. Do not use liquid cleaners or aerosol cleaners.
2. **Heat Sources** - Do not install the unit near any heat sources such as radiators, heaters, stoves, or other equipment (including amplifiers) that produce heat.
3. **Ventilation** - Any openings in the unit enclosure are provided for ventilation to prevent overheating and ensure reliable operation. Do not block or cover these openings. Do not place the unit in an enclosure unless proper ventilation is provided, or the manufacturer's instructions have been adhered to.
4. **Water** - Do not use this unit near water, for example near a bathtub, washbowl, sink, laundry basket, in a damp or wet basement, near a swimming pool, in an outdoor installation, or in any area classified as a wet location. To reduce the risk of fire or electrical shock, do not expose this unit to rain or moisture.
5. **Object and liquid entry** - Never push objects of any kind into this unit through openings as they may touch dangerous voltage points or short-out parts that could result in a fire or electrical shock. Never spill liquid of any kind on the unit. Do not place objects filled with liquids, such as vases or cups, on the unit.
6. **Lightning** - For added protection during a lightning storm, or when leaving this unit unattended and unused for long periods, unplug the unit from the wall outlet and disconnect the cable system. This will prevent damage to the unit from lightning and power line surges.
7. **Controls adjustment** - Adjust only those controls specified in the operating instructions. Improper adjustment of other controls may cause damage to the unit. Use of controls or adjustments, or performance of procedures other than those specified, may result in hazardous radiation exposure.
8. **Overloading** - Do not overload outlets and extension cords. This can cause fire or electrical shock.
9. **Power cord and plug protection** - Protect the plug and power cord from foot traffic, being pinched by items placed upon or against them at electrical outlets, and its exit from the unit. For units intended to operate with 230 VAC, 50 Hz, the input and output power cord must comply with the latest versions of *IEC Publication 227* or *IEC Publication 245*.
10. **Power disconnect** - Units with or without ON/OFF switches have power supplied to the unit whenever the power cord is inserted into the power source; however, the unit is operational only when the ON/OFF switch is in the ON position. The power cord is the main power disconnect device for switching off the voltage for all units.

11. **Power sources** - Operate the unit only from the type of power source indicated on the label. Before proceeding, be sure to disconnect the power from the cable to be installed into the unit.
 - For battery powered units, refer to the operating instructions.
 - For external power supplied units, use only the recommended or approved power supplies.
 - For limited power source units, this power source must comply with *EN60950*. Substitutions may damage the unit or cause fire or shock.
 - For 24 VAC units, voltage applied to the unit's power input should not exceed $\pm 10\%$, or 28 VAC. User-supplied wiring must comply with local electrical codes (Class 2 power levels). Do not ground the supply at the terminals or at the unit's power supply terminals.
 - If unsure of the type of power supply to use, contact your dealer or local power company.
12. **Servicing** - Do not attempt to service this unit yourself. Opening or removing covers may expose you to dangerous voltage or other hazards. Refer all servicing to qualified service personnel.
13. **Damage requiring service** - Unplug the unit from the main AC power source and refer servicing to qualified service personnel when any damage to the equipment has occurred, such as:
 - the power supply cord or plug is damaged;
 - exposure to moisture, water, and/or inclement weather (rain, snow, etc.);
 - liquid has been spilled in or on the equipment;
 - an object has fallen into the unit;
 - unit has been dropped or the unit cabinet is damaged;
 - unit exhibits a distinct change in performance;
 - unit does not operate normally when the user correctly follows the operating instructions.
14. **Replacement parts** - Be sure the service technician uses replacement parts specified by the manufacturer, or that have the same characteristics as the original parts. Unauthorized substitutions may cause fire, electrical shock, or other hazards.
15. **Safety check** - Safety checks should be performed upon completion of service or repairs to the unit to ensure proper operating condition.
16. **Installation** - Install in accordance with the manufacturer's instructions and in accordance with applicable local codes.
17. **Attachments, changes or modifications** - Only use attachments/accessories specified by the manufacturer. Any change or modification of the equipment, not expressly approved by Bosch, could void the warranty or, in the case of an authorization agreement, authority to operate the equipment.

Safety Precautions



DANGER! High risk:

This symbol indicates an imminently hazardous situation such as “Dangerous Voltage” inside the product. If not avoided, this will result in an electrical shock, serious bodily injury, or death.



WARNING! Medium risk:

Indicates a potentially hazardous situation. If not avoided, this could result in serious bodily injury or death.

CAUTION! Medium risk:

Indicates a potentially hazardous situation. If not avoided, this may result in minor or moderate injury. Alerts the user to important instructions accompanying the unit.



CAUTION! Low risk: (without safety alert symbol)

Indicates a potentially hazardous situation. If not avoided, this may result in property damage or risk of damage to the unit.



NOTICE!

This symbol indicates information or a company policy that relates directly or indirectly to the safety of personnel or protection of property.

Important Notices



Accessories - Do not place this unit on an unstable stand, tripod, bracket, or mount. The unit may fall, causing serious injury and/or serious damage to the unit. Use only with the cart, stand, tripod, bracket, or table specified by the manufacturer. When a cart is used, use caution and care when moving the cart/apparatus combination to avoid injury from tip-over. Quick stops, excessive force, or uneven surfaces may cause the cart/unit combination to overturn. Mount the unit per the manufacturer's instructions.

All-pole power switch - Incorporate an all-pole power switch, with a contact separation of at least 3 mm in each pole, into the electrical installation of the building.

If it is needed to open the housing for servicing and/or other activities, use this all-pole switch as the main disconnect device for switching off the voltage to the unit.

Camera grounding - For mounting the camera in potentially damp environments, ensure to ground the system using the ground connection of the power supply connector (see section: Connecting external power supply).

Camera lens - An assembled camera lens in the outdoor housing must comply and be tested in accordance with *UL/IEC60950*. Any output or signal lines from the camera must be SELV or Limited Power Source. For safety reasons the environmental specification of the camera lens assembly must be within the environmental specification of -10 °C (14 °F) to 50 °C (122 °F).

Camera signal - Protect the cable with a primary protector if the camera signal is beyond 140 feet, in accordance with *NEC800 (CEC Section 60)*.

Coax grounding:

- Ground the cable system if connecting an outside cable system to the unit.
- Connect outdoor equipment to the unit's inputs only after this unit has had its grounding plug connected to a grounded outlet or its ground terminal is properly connected to a ground source.

- Disconnect the unit's input connectors from outdoor equipment before disconnecting the grounding plug or grounding terminal.
- Follow proper safety precautions such as grounding for any outdoor device connected to this unit.

U.S.A. models only - *Section 810 of the National Electrical Code, ANSI/NFPA No.70*, provides information regarding proper grounding of the mount and supporting structure, grounding of the coax to a discharge unit, size of grounding conductors, location of discharge unit, connection to grounding electrodes, and requirements for the grounding electrode.

**NOTICE!**

This device is intended for use in public areas only.

U.S. federal law strictly prohibits surreptitious recording of oral communications.



Your Bosch product was developed and manufactured with high-quality material and components that can be recycled and reused. This symbol means that electronic and electrical appliances, which have reached the end of their working life, must be collected and disposed of separately from household waste material. Separate collecting systems are usually in place for disused electronic and electrical products. Please dispose of these units at an environmentally compatible recycling facility, per *European Directive 2002/96/EC*.

Environmental statement - Bosch has a strong commitment towards the environment. This unit has been designed to respect the environment as much as possible.

Electrostatic-sensitive device - Use proper CMOS/MOS-FET handling precautions to avoid electrostatic discharge.

NOTE: Wear required grounded wrist straps and observe proper ESD safety precautions when handling the electrostatic-sensitive printed circuit boards.

Fuse rating - For security protection of the device, the branch circuit protection must be secured with a maximum fuse rating of 16A. This must be in accordance with *NEC800 (CEC Section 60)*.

Grounding and polarization - This unit may be equipped with a polarized alternating current line plug (a plug with one blade wider than the other blade). This safety feature allows the plug to fit into the power outlet in only one way. If unable to insert the plug fully into the outlet, contact a locally certified electrician to replace the obsolete outlet. Do not defeat the safety purpose of the polarized plug.

Alternately, this unit may be equipped with a 3-pole grounding plug (a plug with a third pin for earth grounding). This safety feature allows the plug to fit into a grounded power outlet only. If unable to insert the plug into the outlet, contact a locally certified electrician to replace the obsolete outlet. Do not defeat the safety purpose of the grounding plug.

Moving - Disconnect the power before moving the unit. Move the unit with care. Excessive force or shock may damage the unit and the hard disk drives.

Outdoor signals - The installation for outdoor signals, especially regarding clearance from power and lightning conductors and transient protection, must be in accordance with *NEC725* and *NEC800 (CEC Rule 16-224 and CEC Section 60)*.

Permanently connected equipment - Incorporate a readily accessible disconnect device in the building installation wiring.

Pluggable equipment - Install the socket outlet near the equipment so it is easily accessible.

PoE - Never supply power via the Ethernet connection (PoE) when power is already supplied via the power connector.

Power disconnect - Units have power supplied whenever the power cord is inserted into the power source. The power cord is the main power disconnect for all units.

Power lines - Do not locate the camera near overhead power lines, power circuits, or electrical lights, nor where it may contact such power lines, circuits, or lights.

SELV

All the input/output ports are Safety Extra Low Voltage (SELV) circuits. SELV circuits should only be connected to other SELV circuits.

Because the ISDN circuits are treated like telephone-network voltage, avoid connecting the SELV circuit to the Telephone Network Voltage (TNV) circuits.

Video loss - Video loss is inherent to digital video recording; therefore, Bosch Security Systems cannot be held liable for any damage that results from missing video information. To minimize the risk of lost digital information, Bosch Security Systems recommends multiple, redundant recording systems, and a procedure to back up all analog and digital information.



NOTICE!

This is a class A product. In a domestic environment this product may cause radio interference, in which case the user may be required to take adequate measures.

FCC & ICES INFORMATION

(U.S.A. and Canadian Models Only, CLASS A)

This device complies with *part 15* of the *FCC Rules*. Operation is subject to the following conditions:

- this device may not cause harmful interference, and
- this device must accept any interference received, including interference that may cause undesired operation.

Note

This equipment has been tested and found to comply with the limits for a Class A digital device, pursuant to Part 15 of the FCC Rules and ICES-003 of Industry Canada. These limits are designed to provide reasonable protection against harmful interference when the equipment is operated in a commercial environment. This equipment generates, uses, and radiates radio frequency energy and, if not installed and used in accordance with the instruction manual, may cause harmful interference to radio communications. Operation of this equipment in a residential area is likely to cause harmful interference, in which case the user will be required to correct the interference at his expense.

Intentional or unintentional modifications, not expressly approved by the party responsible for compliance, shall not be made. Any such modifications could void the user's authority to operate the equipment. If necessary, the user should consult the dealer or an experienced radio/television technician for corrective action.

The user may find the following booklet, prepared by the Federal Communications Commission, helpful: *How to Identify and Resolve Radio-TV Interference Problems*. This booklet is available from the U.S. Government Printing Office, Washington, DC 20402, Stock No. 004-000-00345-4.

INFORMATIONS FCC ET ICES (commercial applications)

(modèles utilisés aux États-Unis et au Canada uniquement, CLASSE A)

Ce produit est conforme aux normes FCC partie 15. la mise en service est soumise aux deux conditions suivantes:

- cet appareil ne peut pas provoquer d'interférence nuisible et
- cet appareil doit pouvoir tolérer toutes les interférences auxquelles il est soumis, y compris les interférences qui pourraient influencer sur son bon fonctionnement.

AVERTISSEMENT: Suite à différents tests, cet appareil s'est révélé conforme aux exigences imposées aux appareils numériques de Classe A en vertu de la section 15 du règlement de la Commission fédérale des communications des États-Unis (FCC). Ces contraintes sont

destinées à fournir une protection raisonnable contre les interférences nuisibles quand l'appareil est utilisé dans une installation commerciale. Cette appareil génère, utilise et émet de l'énergie de fréquence radio, et peut, en cas d'installation ou d'utilisation non conforme aux instructions, générer des interférences nuisibles aux communications radio. L'utilisation de ce produit dans une zone résidentielle peut provoquer des interférences nuisibles. Le cas échéant, l'utilisateur devra remédier à ces interférences à ses propres frais.

Au besoin, l'utilisateur consultera son revendeur ou un technicien qualifié en radio/télévision, qui procédera à une opération corrective. La brochure suivante, publiée par la Commission fédérale des communications (FCC), peut s'avérer utile : « How to Identify and Resolve Radio-TV Interference Problems » (Comment identifier et résoudre les problèmes d'interférences de radio et de télévision). Cette brochure est disponible auprès du U.S. Government Printing Office, Washington, DC 20402, États-Unis, sous la référence n° 004-000-00345-4.

AVERTISSEMENT: Ce produit est un appareil de Classe A. Son utilisation dans une zone résidentielle risque de provoquer des interférences. Le cas échéant, l'utilisateur devra prendre les mesures nécessaires pour y remédier.

Disclaimer

Underwriter Laboratories Inc. ("UL") has not tested the performance or reliability of the security or signaling aspects of this product. UL has only tested fire, shock and/or casualty hazards as outlined in UL's *Standard(s) for Safety for Closed Circuit Television Equipment, UL 2044*. UL Certification does not cover the performance or reliability of the security or signaling aspects of this product.

UL MAKES NO REPRESENTATIONS, WARRANTIES, OR CERTIFICATIONS WHATSOEVER REGARDING THE PERFORMANCE OR RELIABILITY OF ANY SECURITY OR SIGNALING RELATED FUNCTIONS OF THIS PRODUCT.

Disclaimer

Underwriter Laboratories Inc. ("UL") has not tested the performance or reliability of the security or signaling aspects of this product. UL has only tested fire, shock and/or casualty hazards as outlined in UL's *Standard(s) for Safety for Information Technology Equipment, UL 60950-1*. UL Certification does not cover the performance or reliability of the security or signaling aspects of this product.

UL MAKES NO REPRESENTATIONS, WARRANTIES, OR CERTIFICATIONS WHATSOEVER REGARDING THE PERFORMANCE OR RELIABILITY OF ANY SECURITY OR SIGNALING-RELATED FUNCTIONS OF THIS PRODUCT.

Copyright

This user guide is the intellectual property of Bosch Security Systems, Inc. and is protected by copyright.

All rights reserved.

Trademarks

All hardware and software product names used in this document are likely to be registered trademarks and must be treated accordingly.



NOTICE!

This user guide has been compiled with great care and the information it contains has been thoroughly verified. The text was complete and correct at the time of printing. The ongoing development of the products may mean that the content of the user guide can change without notice. Bosch Security Systems accepts no liability for damage resulting directly or indirectly from faults, incompleteness or discrepancies between the user guide and the product described.

Customer Support and Service

If this unit needs service, contact the nearest Bosch Security Systems Service Center for authorization to return and shipping instructions.

Service Centers

USA

Repair Center

Telephone: 800-566-2283

Fax: 800-366-1329

E-mail: repair@us.bosch.com

Customer Service

Telephone: 888-289-0096

Fax: 585-223-9180

E-mail: security.sales@us.bosch.com

Technical Support

Telephone: 800-326-1450

Fax: 585-223-3508 or 717-735-6560

E-mail: technical.support@us.bosch.com

Canada

Telephone: 514-738-2434

Fax: 514-738-8480

Europe, Middle East, Africa Region

Repair Center

Telephone: 31 (0) 76-5721500

Fax: 31 (0) 76-5721413

E-mail: RMADesk.STService@nl.bosch.com

Asia Region

Repair Center

Telephone: 65 63522776

Fax: 65 63521776

E-mail: rmahelpdesk@sg.bosch.com

Customer Service

Telephone: 86 (0) 756 7633117 or

86 (0) 756 7633121

Fax: 86 (0) 756 7631710

E-mail: customer.service@cn.bosch.com

Warranty and more information

For additional information and warranty queries, please contact your Bosch Security Systems representative or visit our website at www.boschsecurity.com.

2 Unpacking

This equipment should be unpacked and handled with care. If an item appears to have been damaged in shipment, notify the shipper. Verify that all parts shown in the Parts List have been included. If any items are missing, notify your Bosch Security Systems Sales or Customer Service Representative.

The original packing carton is the safest container in which to transport the unit. Save it for possible future use.

2.1 Parts List

The following table lists the components:

Qty	Item
1	LTC 8601 Series or LTC 8801 Series Main CPU card cage
1	LTC 8610/01 CPU module or LTC 8810/01 CPU module
1	LTC 8805 Series Power Supply
1	AC power cord (either for 120 VAC or 220 - 240 VAC)
1	Fuse kit
1	This installation manual

3 Service

If the unit needs repair, contact the nearest Bosch Security Systems Service Center for authorization to return and shipping instructions.

Service Centers

- USA
 - **Repair Center**
Telephone: 800-566-2283
Fax: 800-366-1329
E-mail: repair@us.bosch.com
 - **Customer Service**
Telephone: 888-289-0096
Fax: 585-223-9180
E-mail: security.sales@us.bosch.com
 - **Technical Support**
Telephone: 800-326-1450
Fax: 585-223-3508 or 717-735-6560
E-mail: technical.support@us.bosch.com
- Canada
Telephone: 514-738-2434
Fax: 514-738-8480
- Europe, Middle East, Africa Region
 - **Repair Center**
Telephone: 31 (0) 76-5721500
Fax: 31 (0) 76-5721413
E-mail: RMADesk.STService@nl.bosch.com
- Asia Region
 - **Repair Center**
Telephone: 65 63522776
Fax: 65 63521776
E-mail: rmahelpdesk@sg.bosch.com
 - **Customer Service**
Telephone: 86 (0) 756 7633117 or
86 (0) 756 7633121
Fax: 86 (0) 756 7631710
E-mail: customer.service@cn.bosch.com

For additional information, see www.boschsecurity.com.

4 Description

These Allegiant video switcher/control systems combine both switching and computer technology to provide powerful performance and unique system features for the security user. Offering full matrix switching capability, these systems can be programmed to display the video from any camera on any monitor, either manually or via independent automatic switching sequences.

The LTC 8600 Series Allegiant system can handle up to 128 cameras and 16 monitors in a full crosspoint configuration. It can also accommodate 512 alarm points, up to 16 keyboards, a computer system console port, and a logging printer port.

The LTC 8800 Series Allegiant system can handle up to 256 cameras and 64 monitors in a full crosspoint configuration. It can also accommodate 1024 alarm points, up to 32 keyboards, a computer system console port, and a logging printer port.

These systems can be programmed with up to 60 sequences that can be run independently of each other, in either a forward or reverse direction. Any of the sequences can utilize the SalvoSwitching capability where any number of system monitors may be selected to switch as a synchronized group. Using the optional LTC 8059/00 Master Control Software (MCS) package or the LTC 8850/00 Bosch Graphical User Interface (GUI), sequences can be made to activate and deactivate automatically, based upon the time of day and the day of week.

The series supports variable speed control and full programming functions of AutoDome® Series dome cameras. In addition, support for on-site receiver/driver units provide operators with control of pan, tilt, zoom, multiple pre-positions, four (4) auxiliaries, autopan, and random scan using conventional camera/lens/housings.

With the addition of an external LTC 8540/00 Alarm Interface unit, an external contact closure or logic level can be used to automatically display any camera. Any monitor or group of monitors can be set to display cameras under alarm conditions. The base system contains three (3) built-in alarm response modes: basic, auto-build, and sequence and display. In addition to these three (3) modes, the PC based software packages offer the ability to combine any or all three (3) standard modes. Alarm video may be selected to reset either manually or automatically. In addition, a 16-character alarm title can be selected to appear instead of the camera title during alarm conditions.

System operation and programming is accomplished using a full-function, ergonomically designed keyboard. Multiple keyboards may be used in the system. Built-in operator priority levels and the ability to restrict certain operators from controlling designated functions provide maximum flexibility.

These systems include a 48-character on-screen display for time-date, camera number, camera ID (16 characters), and monitor (12 characters) or status information. A user selectable option provides the ability to display a 3rd line of on-screen text. This 3rd line can be configured to display up to 24 additional camera title characters (40 characters total) or a 12-character monitor title.

The on-screen display is also user selectable to operate in “6-digit Camera ID” mode. When enabled, 2-digit “site numbers” are displayed in addition to the 4-digit camera number. The 2-digit site number feature is especially useful when groups of cameras are located in separate buildings, floors, or other common areas.

When programming camera ID and monitor titles, over 1000 different characters are available.

Enhanced programming and switching features can be obtained by utilizing a standard Windows® equipped PC and the optional LTC 8059/00 MCS package or the LTC 8850/00 GUI Software. A user friendly spreadsheet format provides the ability to enter camera titles, enter operator names, schedule up to 64 timed events, change

system parameters, program camera sequences, install lockouts, and access the advanced alarm handling screens with speed and efficiency. The programmed information may then be transferred into the Allegiant system, stored on disk, or printed from a PC.

The LTC 8850/00 Bosch GUI Software is designed around an intuitive graphic-based interface. This software provides high performance programming, control, and monitoring of all system functions by using on-screen icons to reflect real time status of the devices controlled by the system.

The LTC 8850/00 GUI Software also provides the ability to monitor system status events. System alarms, switching functions, sequence events, and keyboard actions, and video loss information can be viewed in real time on the PC screen and, if desired, logged to the PC hard drive. The LTC 8850/00 GUI Software can also be used to enable a special on-screen icon for identifying controllable cameras.

The CPU inside these matrix switchers supports powerful macro capabilities. The macros can be activated using system keyboards, system time event functions, alarm activations, and via special function icons in the LTC 8850/00 GUI Software.

These systems can serve as the master switcher in a SatelliteSwitch configuration. This innovative feature enables a single master Allegiant system to communicate with remotely located "Satellite" systems. Any Allegiant system model can serve as a remote Satellite switcher. This powerful feature permits the design of a distributed matrix video switching system with control at one central location and individual control at the local sites. The main control site can view/control local cameras plus cameras located at any of the remotely distributed Satellite sites. The Satellite sites can view/control only cameras associated with their own site.

5 Allegiant Feature Summary Table

These Allegiant Series systems are available in two (2) operating configurations: a base system and the base system with an optional PC based software package. The base system includes features required for most switching/controller systems.

The addition of the optional LTC 8059/00 MCS or optional LTC 8850/00 GUI Software package enables the user to customize the system's configuration using a menu driven program run on any personal computer using Microsoft® Windows NT®, Windows 2000 or Windows XP.

The following TABLE lists available features.

Feature	Base System	With Optional Allegiant PC-Based Software
1. Full camera switching/control on all monitors	Y	Y
2. Multiple keyboards (up to 16 with LTC 8600; 32 with LTC 8800)	Y	Y
3. Multiple alarm inputs (up to 512 with LTC 8600; 1024 with LTC 8800)	Y	Y
4. Three (3) user-selectable pre-defined alarm response modes	Y	Y
5. Full control of on-site receiver/drivers	Y	Y
6. SalvoSwitching feature	Y	Y
7. 60 Programmable sequences	Y	Y
8. Alarm call-up of pre-position scenes	Y	Y
9. RS-232 Interface ports for computer, logging printer, etc.	Y	Y
10. Keyboard log-on/log-off function	Y	Y
11. User-selectable password security	Y	Y
12. 16-Character camera titles and 12-character monitor titles	Y	Y
13. User-selected 40 character camera titles using third line of on-screen text	Y	N
14. User-selectable 2-digit site plus 4-digit camera mode	Y	Y
15. Format selection time/date format	Y	Y
16. Local keyboard test function	Y	Y
17. Table and sequence printout feature	Y	Y
18. Parameter designation for RS-232 communication	Y	Y
19. Integral video loss detection	N	Y
20. Satellite configurations	N	Y
21. Restrict user/keyboard access to cameras	N	Y
22. Restrict user/keyboard access to receiver/drivers	N	Y
23. Restrict user access to keyboard	N	Y
24. Restrict user/keyboard access to monitors	N	Y
25. Designate user name and ID number	N	Y
26. Designate zoned alarm call-ups	N	Y
27. Powerful alarm response features	N	Y
28. Designate displayed camera number	N	Y
29. Designate receiver/driver functions on alarm	N	Y
30. Program 64 time activated events	N	Y
31. Designate receiver/driver functions in sequences	N	Y
32. Broadcast monitor messages	N	Y
33. Alarm title designation	N	Y
34. Personal computer displayed monitoring of system status	N	Y

In addition, these systems provide the capability to control on-site receiver/driver units and the AutoDome Series of integral pan/tilt/zoom/cameras.

These systems contain a logging printer output port, so an inexpensive RS-232 serial printer or some other form of logging software can be used to capture log data. This provides a permanent record showing time and date of changes to system status, such as:

- Incoming alarms
- Acknowledgment of alarms by users
- Loading sequences
- User log-on to keyboard or console port
- Console broadcast message
- Console transfer of system tables
- Activation of time event functions
- Power up reset message
- Video loss message

The printer may also be used to provide a hard copy of all system configuration Tables and Sequences.

6 System Components

6.1 LTC 8601 Series Systems

- **LTC 8601 Series Main CPU Bay**
A modular equipment bay which contains the system's microprocessor module (LTC 8610/01), the power supply module (LTC 8805 Series), and several video input and video output modules (see below).
- **LTC 8621/00 Video Input Module**
Individual cards placed in LTC 8601 Series bays to accept inputs from cameras and other video sources. Each card provides 16 video input channels with switch selectable terminations.
- **LTC 8834/00 Video Output Modules**
Individual cards placed in LTC 8601 Series bays to provide video outputs to monitors and DVRs. Each card provides four (4) video output channels.
- **LTC 8600 Series System Capacities**
Up to eight (8) video input modules; 16 inputs per module.
Up to four (4) video output modules; four (4) outputs per module.
Total: 128 inputs and 16 outputs.
Satellite configuration input capacity: 1152.

6.2 LTC 8800 Series Systems

- **LTC 8801 Series Main CPU Bay**
A modular equipment bay which contains the system's microprocessor module (LTC 8810/01), the power supply module (LTC 8805 Series), and several video input and video output modules (see below).
- **LTC 8802 Series Monitor Expansion Bay**
A modular equipment bay which contains a Data Receiver module (LTC 8816/01), the power supply module (LTC 8805 Series), and several video input and video output modules (see below). The Monitor Expansion bay is required in system configurations having more than 32 monitors. The Monitor Expansion bay can also accommodate up to eight (8) additional keyboards.
- **LTC 8821/00 Video Input Module**
Individual cards placed in LTC 8801 Series or LTC 8802 Series bays to accept inputs from cameras and other video sources. Each card provides 32 video input channels with switch selectable terminations.
- **LTC 8834/00 Video Output Modules**
Individual cards placed in LTC 8801 Series or LTC 8802 Series bays to provide outputs to monitors and DVRs. Each card provides four (4) video output channels.
- **LTC 8800 Series System Capacities**

- LTC 8801 Main Bay:
Up to eight (8) video input modules; 32 inputs per module.
Up to eight (8) video output modules; four (4) outputs per module.
Subtotal: 256 inputs and 32 outputs on main bay.
- Monitor Expansion Bay:
Up to eight (8) video input modules (duplicating modules on main bay).
Up to eight (8) extra output modules (providing four (4) additional outputs each).
Subtotal: 32 extra outputs added on to the main bay's outputs.
- Total:
256 maximum inputs; 64 maximum outputs.
Satellite configuration input capacity: 2304.

7 System Accessory Components

The Allegiant Series accessory products provide many optional features to the base system. A brief description of accessory products is provided below. Complete specification information can be found in respective product data sheets. Applicable accessories are designed to be compatible throughout the Allegiant Series.

7.1 LTC 8540/00 Alarm Interface Unit

The LTC 8540/00 is an alarm gathering unit which accepts up to 64 dry contact closures or logic level inputs from remote sensing devices such as door contacts, PIRs, etc. and then reports this alarm information to the main CPU bay. Alarm inputs may be configured in groups of 32 to accept either normally open or normally closed contacts. The LTC 8540/00 unit provides eight (8) relay outputs which can be used to drive external alerting devices, DVR's, and other devices.

7.2 LTC 8568 and LTC 8768 Signal Distribution Units

The signal distribution is a main site control code distribution and line driver units are available for communicating to receiver/drivers, switcher followers, and Allegiant Satellite systems. The LTC 8568/00 Signal Distribution Unit provides 32 separate outputs for driving up to 256 remote devices. Either "star" or "daisy chain" wiring configurations may be used. The LTC 8768/00 Signal Distribution unit is similar to the LTC 8568/00, except that it provides 64 separate outputs for driving up to 512 remote devices.

7.3 IntuiKey Series KBD-Universal Keyboard

The IntuiKey KBD-UNIVERSAL is a full function keyboard used for control and programming of the Allegiant Series matrix switchers. Backlit LCD screens provide multi-language display of softkey menus and status information. Integral variable speed joystick and zoom lens controls are standard for operating fixed or variable speed pan/tilt/zoom equipped cameras. Both Allegiant RS-485 and Allegiant RS-232 keyboard protocols are supported.

In addition to the Allegiant Series, the KBD-UNIVERSAL model IntuiKey can be used to simultaneously control Divar Series DVRs, System4 Series multiplexers, and access ADIM based DVR control screens.

7.4 KBD-Rack Keyboard Mounting Kit

Rack-mounting kit designed to provide vertical, horizontal, or inclined mounting for IntuiKey keyboards.

7.5 LTC 8555 Series Keyboards

The LTC 8555 Series keyboards are compact, full function keyboards for use with Allegiant Series matrix switchers. LED readouts display real time system status information. Includes variable speed joystick and zoom lens controls for operating fixed or variable speed pan/tilt/zoom equipped cameras. The keyboards are available in the following configurations:

Model Number	Top Bezel Graphics	Communication Protocol
LTC 8555/00	English	RS-485
LTC 8555/01	Icons	RS-485
LTC 8555/02	English	RS-232
LTC 8555/03	Icons	RS-232

The RS-232 model keyboards connect to an Allegiant's console port or to a port provided by an LTC 8712 Console Expander accessory unit. Up to four (4) may be connected to a single LTC 8712 unit. When used with dial-up type phone modems, these keyboards provide rudimentary dialing capability.

7.6 LTC 8558/00 Keyboard Extension Cable

The LTC 8558/00 keyboard extension cable has a six-conductor extension cable that carries data/power for remote keyboards up to 30 m (100 ft) away from the main CPU bay.

7.7 LTC 8557 Series Keyboard Extension Kits

The LTC 8557 Series keyboard extension cable is an interface kit used to remote the IntuiKey Series or LTC 8555 Series keyboards up to 1.5 km (5000 ft) away from the main CPU bay. Customer supplied 0.5 mm² (24 AWG) shielded-twisted pair (Belden 9841 or equivalent) required between the main CPU bay site and keyboard site. Kit provides two (2) junction boxes, interface cable, and appropriate keyboard power supply.

7.8 LTC 8560 and LTC 8561 Series Receiver/Driver Units

These series of on-site receiver/drivers are designed to receive biphasic control code and convert this data into signals for controlling conventional pan/tilt, zoom lenses, and auxiliary functions. Supplied in an environmentally rated enclosure, these series of receiver/drivers are available in both basic and full-featured models. This unit contains integral local test feature, autopan or random scanning, and is available in several input and output drive voltage versions.

7.9 AutoDome Series

The AutoDome Series comprise an integral camera, a high speed pan/tilt mechanism, a zoom lens, and a receiver/driver system in a compact dome enclosure. Various enclosure mounting options are available for indoor and outdoor applications.

7.10 LTC 8569, LTC 8570, LTC 8571, LTC 8572 Series Code Merger Units

These series are control code merger and line driver units used to combine Allegiant biphasic control code from two (up to four with LTC 8570 and LTC 8572 versions) systems for communicating to AutoDome Series cameras, receiver/drivers, switcher/followers, and Allegiant Satellite systems. The LTC 8569, LTC 8570 Series provides 32 separate outputs capable of driving up to 256 remote devices. The LTC 8571, LTC 8572 Series provides 64 separate outputs capable of driving up to 512 remote devices. Either “star” or “daisy chain” wiring configurations may be used. The unit will accept signal input either from an Allegiant main CPU bay, LTC 8568/00 output, LTC 8780 biphasic output, or an output from another LTC 8569, LTC 8570 Series or LTC 8571, LTC 8572 Series unit. Multiple units may be cascaded to obtain additional outputs.

7.11 LTC 8770 Switcher Follower Series

The LTC 8770 Series is an accessory unit which provides relay contact closures corresponding to cameras displayed on system monitors. The LTC 8770 may be configured to follow manual activations, non-alarmed video, alarmed video, or both. Each unit provides 24 relay contact outputs. In addition, six (6) functional operating modes are available, including one user activated test mode.

7.12 LTC 8712 Series Console Port Expander Units

The LTC 8712 Series “expands” an Allegiant system's console port to permit up to four external computing devices to communicate with the system via RS-232 protocol. Any computing device that can normally communicate directly with an Allegiant via its RS-232 console port can be used with these port expanders. The external devices may consist of PCs running the Allegiant system's MCS package, the Allegiant GUI, access control systems, Allegiant RS-232 protocol keyboards, or other devices utilizing the Allegiant system's Command Console Language (CCL).

7.13 LTC 8713 Alarm Port Expander Units

The LTC 8713 Series interfaces to the alarm port of an Allegiant system to permit additional LTC 8540/00 Alarm Interface units to be connected. In a LTC 8500 system, two (2) LTC 8540/00 units can be connected to a LTC 8713 Series unit providing up to 128 alarm inputs. In LTC 8600 systems, up to eight (8) LTC 8540 Series units can be connected to three (3) LTC 8713 Series unit providing up to 512 alarm inputs. In LTC 8800 systems, up to sixteen LTC 8540 Series units can be connected to five (5) LTC 8713 Series unit providing up to 1024 alarm inputs.

7.14 LTC 8714, LTC 8715 Series Keyboard Port Expander Units

The LTC 8714 Series and the LTC 8715 Series are port expander accessory units used to provide additional keyboard capacity for LTC 8600 and LTC 8800 Series Allegiant systems. A single LTC 8714 Series unit can be used to interface up to eight (8) additional keyboards in an LTC 8600 series Allegiant system. In LTC 8800 systems, up to three (3) LTC 8714 Series units can be connected to a single LTC 8715 Series to provide a quantity of 24 “port expanded” keyboards for a total of 32 system keyboards. Alternatively, all 32 system keyboards can be connected using four (4) LTC 8714 Series units and a single LTC 8715 Series unit.

7.15 LTC 8780 Series Data Converter Units

The LTC 8780 Series are accessory units that convert the Allegiant system's biphasic control code into RS-232, or converts RS-232 back to biphasic code. This provides the capability of transmitting the control code over conventional RS-232 transmission mediums such as phone modems, fiber optics, microwaves, etc. The unit will accept the biphasic control code generated by an Allegiant main CPU bay, an LTC 8568/00 Signal Distribution unit, or an output from an LTC 8569, an LTC 8570, an LTC 8571, or an LTC 8572 Series Code Merger unit.

7.16 LTC 8781 Series Data Converter Units

The LTC 8781 Series are accessory units that decode the Allegiant system's encoded time/date information generated on the biphasic control code line and convert it into an RS-422 GPS format. This time/date information can be used to interface into external time/date inserter products (such as the Kalatel KTS-53-16), which are designed to be synchronized via a GPS signal.

7.17 LTC 8016/90 Bilinx™ Data Interface Unit

The LTC 8016/90 Allegiant Bilinx Data Interface unit is an accessory used for communicating over-the-coax, with up to 16 Bilinx-capable AutoDome and/or Dinion™ Series cameras. The LTC 8016 provides complete control of pan/tilt/zoom, auxiliaries, and pre-position functions of Bilinx enabled AutoDome Series cameras. In addition, complete programming of Dinion Series cameras and AutoDomes via their on-screen menus is supported. Bilinx technology also supports camera-generated event reporting to the Allegiant. This connection allows remote alarm inputs and motion event data to be sent by the camera to the Allegiant without the need for additional wiring between the camera site and the main control location. The LTC 8016 can also be used to transmit Bilinx communications over a number of video transmission systems. Example devices include fiber optic links and external balun devices that use CAT5 twisted pair cables for video communication.

7.18 LTC 8785 Series Code Converters

The LTC 8785 Series code converter units are designed for use in older Allegiant systems that have been upgraded to support 'variable speed' control code protocol. The LTC 8785 units are used to provide a source of 'fixed speed' control code when the system is generating the newer 'variable speed' control code preferred by the AutoDome Series of PTZ cameras. The LTC 8785 would receive the variable speed control code from the Allegiant via its LTC 8568/00 Signal Distribution unit and convert it into the appropriate fixed speed control code. The 'fixed speed' control code outputs from the LTC 8785 Series connect to the older TC8561 Series receiver/drivers using the existing field cabling.

7.19 LTC 8782 Series Code Translator Units

The LTC 8782 Series code translators are accessory units that convert biphase code to other manufacturers' control codes, or convert other manufacturers' codes to biphase. Many of the most popular protocol codes are supported, including Pelco[®], Vicon[®], American Dynamics[®], Sensormatic[®], Kalatel[®], Diamond Electronics[®], and Javelin[®]. Fixed and variable speed codes are supported where applicable.

7.20 LTC 8808/00 Series Video Interconnect Panel

The LTC 8808/00 Series video interconnect panel is an optional accessory item which provides certain Allegiant system models the ability to loop their video inputs. This patch panel contains 32 BNC connectors on front for external video connections, and two 16-contact ribbon connectors on the rear. Two (2) 16-conductor ribbon cables are included for interfacing the patch panel to the video looping connectors found on the rear panel of the equipment bays. The patch panel is one standard EIA 19-inch rack unit high, and one unit wide.

7.21 LTC 8059/00 Master Control Software

The Allegiant LTC 8059/00 MCS brings the familiarity of the personal computer to those who supervise closed circuit television systems. Running on a Windows based compatible computer, this software is the human interface that makes it quick and easy to configure an entire Allegiant system.

With the MCS package, users can set and change an Allegiant's system parameters; program camera sequences; lock cameras, monitors, remotes, and keyboards from certain users; and perform many other system control features. Users can also view system activity with real time monitoring of the system status, and if desired, log this information to a file stored on the hard drive.

7.22 LTC 8850/00 Windows Based Graphical User Interface Software

The LTC 8850/00 GUI Software is a PC-based program designed for complete control and programming of the Allegiant Series of matrix switchers. With a mouse click on an icon, operators can easily take control of system hardware devices, including cameras, monitors, and alarms. Jumping from one map to another is easily accomplished using special link icons. System Administrators can easily call-up the included Allegiant LTC 8059/00 MCS module for entering the Allegiant system's camera titles, sequences, alarm responses, and many other configuration features. Communication between the GUI workstations and an Allegiant system can be made using an RS-232 link, or via a Windows based-PC network.

7.23 SFT-INTSRV Allegiant Integration Software

The SFT-INTSRV software CD contains three (3) distinct software packages that can be used to integrate external devices with an Allegiant system matrix switcher. Please refer to the following sections for details:

7.23.1 Integration Server

The Integration Server is a versatile software package used to integrate multiple systems that are not ordinarily compatible with each other. These systems can include video switchers, point of sale systems, fire/burglar alarms, access control, or HVAC systems. Devices can be interfaced using any of the following three (3) methods: serial RS-232 connection, digital I/O card, or directly to an Allegiant Switcher via the LTC 8059 MCS program. The Integration Server software is programmed to recognize events as they occur in real time from one or more systems, based upon one of the three (3) integration methods mentioned above. It then reacts to those events by sending commands to another system or systems.

7.23.2 Virtual Allegiant Satellite Application Software

The Virtual Allegiant Satellite Application (VASA) is Bosch's strategic product that allows existing Allegiant customers to transition gradually to pure IP technologies rather than a total and instantaneous replacement. VASA acts as the integration bridge between an existing Allegiant and the new digital based CCTV system (the 'satellite') that uses digital video encoders and decoders. With VASA, the new IP technology is totally transparent to the existing Allegiant users who continue to use their Intuikey CCTV keyboards for video switching and PTZ control on classic analog monitors.

VASA supports the Allegiant LTC 8100 through the LTC 8900 Series matrix switchers. In addition to PTZ control, VASA provides auxiliary and preposition control of the IP-based cameras. VASA improves the ROI on existing capital assets, removes the need for training, and reduces the risk for adopting new technology by incrementally adding to the system. The integration is seamless and the transition is designed to be imperceptible.

7.23.3 Allegiant Satellite SDK

The Allegiant Satellite Software Development Kit (SDK) is a fully supported set of libraries, documentation, and samples targeted at PC-based application software that is used to control 3rd party CCTV matrix systems or manage IP-based digital video networks. Since the SDK can be used to create customized solutions for unique, specific problems, customers looking to integrate an Allegiant matrix system with products offered by other manufacturers is readily accomplished. For the thousands of existing Allegiant customers, it also provides a bridge to integrate or expand their systems with IP based products gradually rather than a total and instantaneous replacement.

When operating in an Allegiant satellite system configuration, an Allegiant master generates switching and PTZ data that is typically used to control a remote Allegiant satellite matrix. Using the SDK, the video switching commands and PTZ data from the master system are converted into an ActiveX interface allowing developers to easily translate this information into formats used to control other original equipment manufacturer's (OEM) systems. The SDK also supports an ability to translate repetitive type Allegiant PTZ commands to their indefinite equivalents, resulting in reduced interface traffic and lower bandwidth demands when controlling IP based networks.

The level of integration available with the SDK results in a robust interface that provides transparent operation to the existing Allegiant operators. Operators continue to use their existing CCTV keyboards for selecting video and control of PTZ devices on the Allegiant monitors. This type of solution improves the return of investment on existing capital assets, removes the need for training, and reduces the risk for adopting new technology by incrementally adding to the system.

The SDK is compatible with all models of the Allegiant Series switchers. In addition to video switching commands and PTZ control, auxiliaries and prepositions are also supported. The SDK is supplied with five sample applications. Three (3) applications use C++ to demonstrate incorporating the SDK in a console, an ATL, and an MFC application. In addition, samples using Visual Basic®, and Microsoft's .NET Framework are included.

7.24 LTC 8506/00 PC-to-Console Port RS-232 Cable

The LTC 8506/00 is an RS-232 grade cable with 9-pin D-connectors on each end that is used to connect an Allegiant's system's console port to a standard PC COM port. This cable is included in the Allegiant LTC 8059 MCS and the LTC 8850 Allegiant GUI packages. Length is approximately 3 m (10 ft).

7.25 LTC 8508/01 Ribbon-to-BNC Interface Cable

The LTC 8508/01 is a 1 m (3 ft) video interface cable with a 34-pin ribbon cable on one end and 16 male BNC connectors on the other end. This cable can be used to loop up to 16-channels of video signals from digital video recorders such as the Divar, Dibos, and DesaXL, or other BNC equipped devices to the ribbon cable connectors located on the rear panels of the LTC 8600 and LTC 8800 Series bays.

7.26 Logging Printer

An optional RS-232 serial printer may be connected to these systems to provide a permanent record of significant system status changes. Time and date is printed for system events such as alarms, start-up after power failure, sequence loading, operator log-on/log-off to keyboards, and download of information from the optional MCS. The printer may also be used to obtain hard copies of all system tables and sequences.

NOTE The printer port does not provide a standardized pin-out connection. If desired, a cable can be made up at installation, by following the cable pin-out information provided at the end of this manual.

LTC 8600 Series Video Switching System

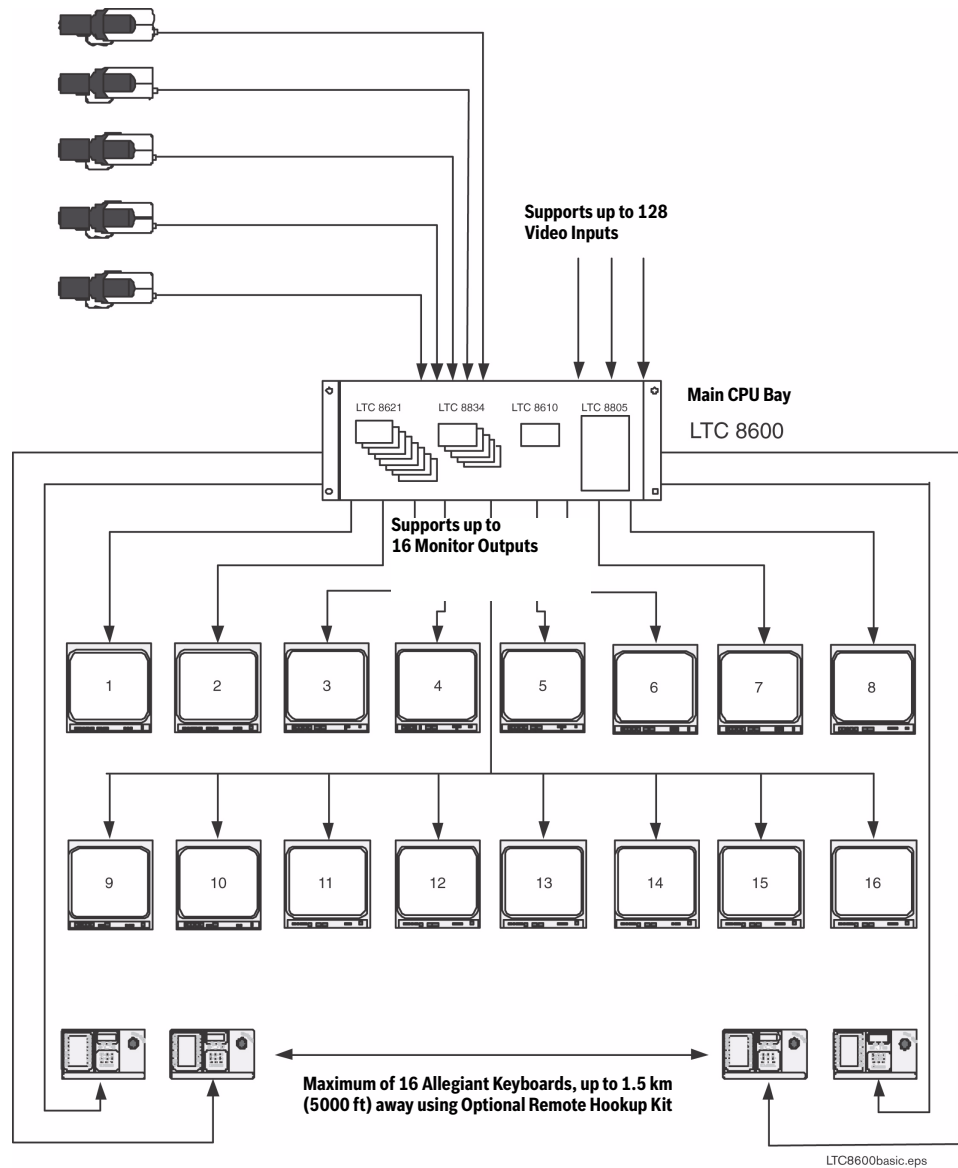

Figure 1: LTC 8600 Series Basic Video Switching Configuration

LTC 8800 Series Single Bay System (256 by 32 Configuration)

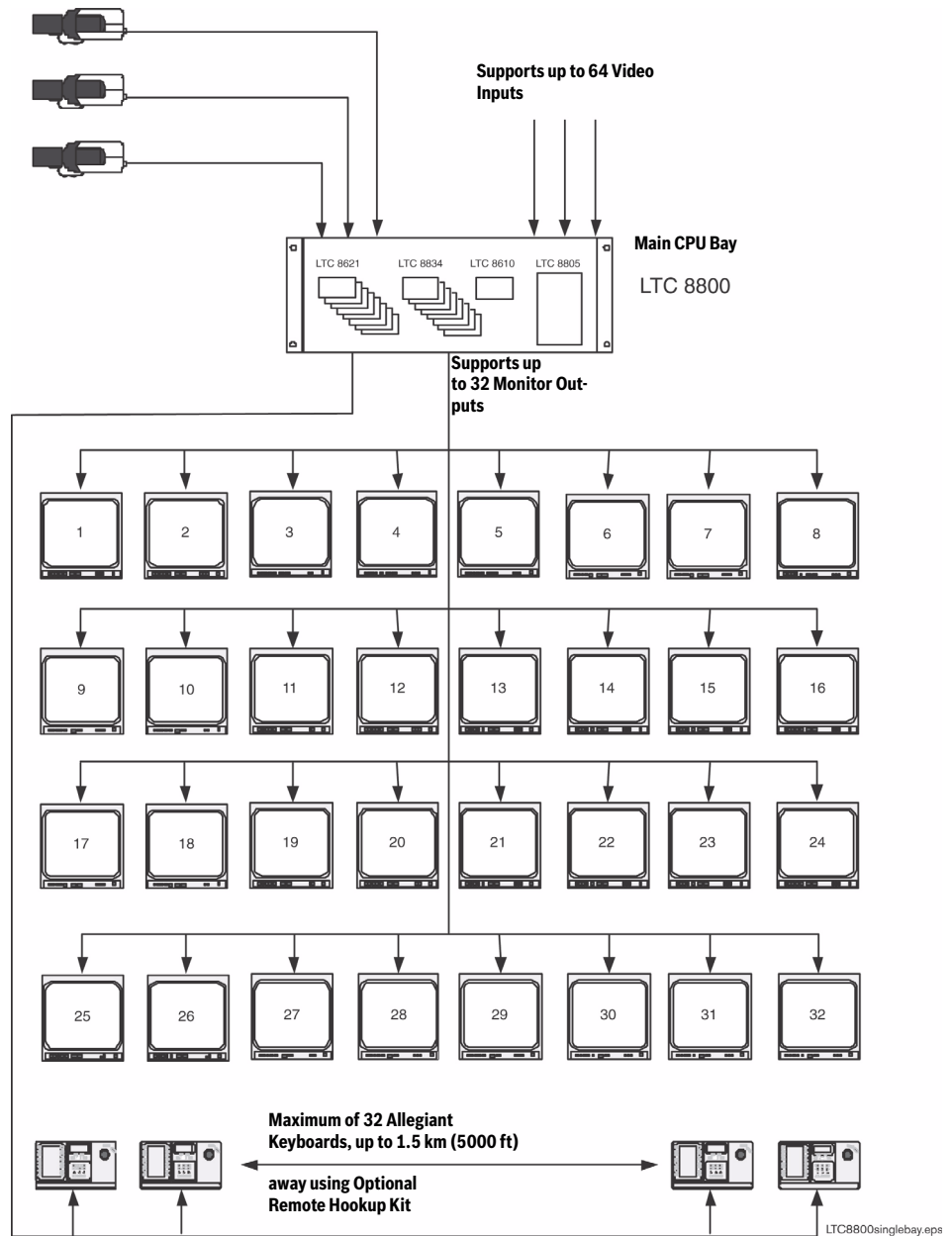

Figure 2: LTC 8800 Series Single Bay Video Switching Configuration

LTC 8800 Series Dual Bay System (256 by 64 Configuration)

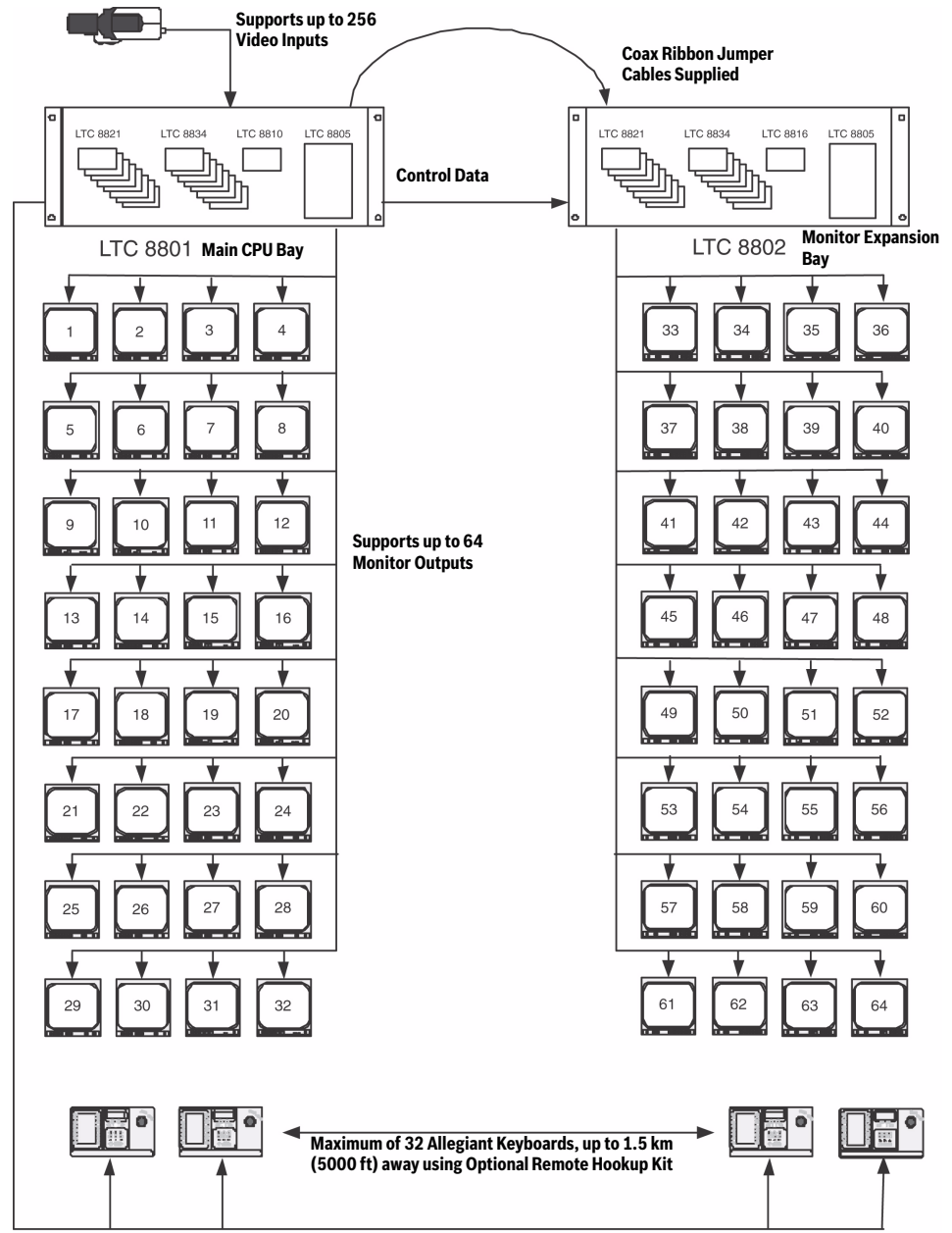

Figure 3: LTC 8800 Series Dual Bay Video Switching Configuration

8 Installation Procedure

8.1 Main CPU Bay Installation

Before discarding the shipping cartons, verify that the various pieces of equipment have no evidence of carrier damage.

CAUTION

Do not apply power to the equipment until instructed to do so.

1. Remove the front panel of the main CPU bay and the front panels of any supplied expansion bay (LTC 8802 Series) by loosening the four (4) corner fasteners.
2. Install the power supply in far right position of the main CPU bay insuring proper alignment and seating of the module into the rear mating connector. Verify that the power supply ON/OFF switch is in the OFF position. Repeat this procedure for any supplied LTC 8802 Series Monitor Expansion bay.
3. Install the four screws and star washers (supplied) on the rear panel of the bay(s) surrounding the power supply line cord to fasten the power supply securely in place.

CAUTION

If the allegiant card cage is to be transported, the main power supply should be removed to prevent possible damage to the bay's internal parts.

4. If the bay(s) are to be installed into a standard 19-inch EIA rack, remove the four (4) rubber bumper foot pads found on the bottom of the bay before installing the unit in the rack. Four (4) holes are provided for mounting the bay(s) in the rack. If any LTC 8802 Series Monitor Expansion bay is supplied, it should be located as close as possible to the LTC 8801 Series Main CPU bay to facilitate cable interconnections.
5. Install the LTC 8600 Series, the LTC 8800 Series, and the LTC 8802 Series Monitor Expansion bays so that there is at least 9 cm (3.5 in.) of clearance above and below the bay. This clearance is necessary to allow for proper cooling of the system. Failure to provide proper clearance may cause the equipment to exceed its recommended operating temperature range.

NOTE

An LTC 8802 Series Monitor Expansion bay should be located close enough to the TC8801 so that you can connect the units with the supplied 2 m (6 ft) data interconnect cable

8.2 Video Input Modules

Termination switches on the Video Input Modules (VIM) must be set to the correct position prior to installation. If necessary, see Section 8.6 "Termination Practices," on page 31 prior to actually installing the VIM on these systems.

The appropriate number of VIMs should be installed in the main bay starting with the left most slot. If the LTC 8802 Series Monitor Expansion Bay is being used, it should receive the same number of VIMs as the main bay. If less than full capacity is

being used, the modules should be inserted in a left-to-right manner so that the lower camera numbers are used first.

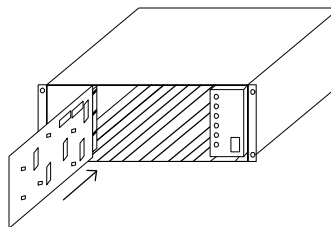

Figure 5: Typical Video Input Module Insertion

The VIMs are identical and are interchangeable within the designated VIM slots without having to make any changes to the module.

8.3 Video Output Modules

Counting from left to right beginning with slot 9, install the appropriate number of Video Output Modules (VOM) into these slots. If fewer than the maximum number of VOMs are installed, there will be empty slots between the Input and the Output Modules, so make sure that the VOMs are inserted into the correct slots.

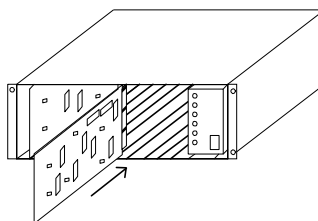

Figure 6: Typical Video Output Module Insertion

If the LTC 8802 Series Monitor Expansion Bay is being used, it should be loaded with VIMs in the same fashion. The Main CPU Bay should be FULLY loaded with 8 output modules before putting output modules into the Monitor Expansion Bay. Remaining output modules are inserted into the Monitor Expansion Bay starting at slot 9. If fewer than the maximum number of outputs are being used, the Monitor Expansion Bay may contain fewer Output Modules than the Main CPU Bay.

All VIMs are identical and are interchangeable within the designated VOM slots.

8.4 CPU Module

The slot to the left of the power supply in the main CPU bay is reserved for the system CPU module.

NOTE The CPU module contains two (2) lithium batteries mounted on the component side of the printed circuit board. A red rectangular insulating tag may be installed in between the top of the batteries and the battery holder clip. This tag prevents battery drainage during stocking. Remove tag if so equipped.

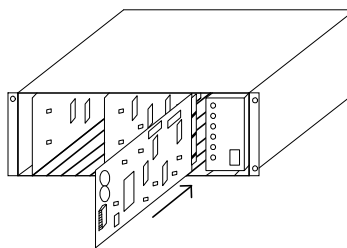

Figure 7: Typical CPU Module Insertion

If an LTC 8802 Series Monitor Expansion is supplied, it will contain an LTC 8816/01 Data Receiving Module in this slot. Install the main bay CPU or data receiver module at this time.

The circuit board contains three (3) 8-position DIP switches for system configuration options. The DIP switches can be used to modify certain system operating conditions. Review the Factory Default Settings Section to determine if it is necessary to change the DIP switches from the factory default positions. For reference, the factory default settings are:

Bay Type	Module	DIP Setting
LTC 8601 Series	LTC 8610/01 CPU	S1 and S3, All OFF S2, Switch 5, 7, and 8 ON; All others OFF
LTC 8801 Series	LTC 8810/01 CPU	S1 and S3, All OFF S2, Switch 5, 7, and 8 ON; All others OFF
LTC 8802 Series	LTC 8816/01	S1 and S3, All OFF S2, Switch 3 and 7 ON; All others OFF

8.5 Camera and Monitor Video Connections

Refer to “Figure 14:” on page 43 for the next series of steps.

Connect the system cameras to the appropriate video inputs, but as a minimum connect one known operating camera to video input #1 on the rear of the main CPU bay. Use only those inputs that correspond to an installed VIM. Special instructions concerning the LTC 8600 Series or the LTC 8800 Series systems, termination, and expansion bays are given in the sections below. Also connect desired monitors to the rear of the main CPU bay, ensuring to connect at least one monitor to video output #1. The video outputs are the left-most column of BNC connectors on the rear of the bay. Use only those outputs that correspond to an installed Video Output Module (VOM).

8.5.1 LTC 8600 Series and LTC 8800 Series Video Input Connections

The LTC 8601 Series and the LTC 8801 Series main bays have 96 direct BNC connectors available for video input. Cameras above 96 require the use of the LTC 8808/00 Video Interconnect (“Patch”) Panel. Each patch panel provides 32 additional BNC connectors for video input.

Patch panels are connected to the rear of the main bay using the supplied ribbon cables. Each cable can carry video for up to 16 cameras. Two (2) cables can be attached to each patch panel to support up to 32 cameras per panel. Each ribbon cable should be attached to the appropriate “VIDEO” connector on the rear of the main bay. The ribbon cable connectors contain a small “key” protrusion formed into one side of the connector to assure proper placement into the mating connectors. Be careful not to force the cables into the mating connectors backwards. For example, the two (2) ribbon cables from the first patch panel (supporting the 32 cam-

eras, numbers 97 through 128) should be attached to the main bay connectors labeled “VIDEO 97-112” and “VIDEO 113-128.” Extra connectors are provided on the main bay for “looping” purposes. If camera inputs are not being looped to other equipment, only one connector for each range of cameras (e.g., “VIDEO 97-112”) needs to be connected.

The LTC 8600 Series system is supplied with one LTC 8808/00 (patch panel plus two (2) TC8809 ribbon cables). This should be installed on the rear of the racking equipment to permit immediate or future connections of camera inputs 97 through 128.

A LTC 8808/00 Patch Panel must be ordered separately for each group of 32 cameras above 96 that will be connected to an LTC 8800 Series system.

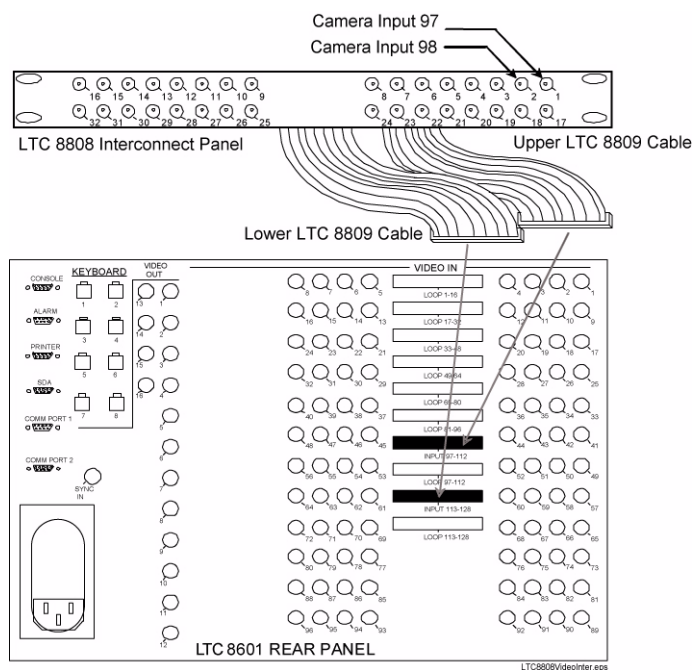

Figure 8: Typical Use of LTC 8808/00 Video Interconnect Panel

Install any supplied LTC 8808/00 Patch Panel on the rear of the racking equipment. Note that additional VIMs ordered in the future may also require the use of LTC 8808/00 Patch Panels. It is recommended to order the appropriate quantities at the time the VIMs are ordered.

8.6 Termination Practices

Video from every video input signal must be “terminated” with a 75 ohm resistance. Each video line should be terminated exactly once. If video from a given camera is going to several different devices, only the last piece of equipment on the video line should be terminated. See the section below for special termination instructions when using a monitor expansion bay. The following sections detail the ways that various Allegiant systems terminate video inputs.

8.6.1 LTC 8600 Series or LTC 8800 Series Video Input Terminations

Each VIM card for an LTC 8600 Series or an LTC 8800 Series system has DIP switches for selecting the termination of each individual video line. To terminate an input line, make sure that the appropriate DIP switch on the VIM card is ON. If non-terminated operation is required for looping purposes, turn the switch OFF (Switch 1 corresponds to the first video input channel of the card).

If looping video inputs are desired, the LTC 8600 Series and the LTC 8800 Series systems may utilize the LTC 8808/00 Video Interconnect Panel. Both bays provide video looping connections which interface to the LTC 8808/00 using coax type ribbon cables supplied with the patch panel. Each LTC 8808/00 provides looping capability for up to 32 video inputs.

8.6.2 LTC 8802 Series Monitor Expansion Bay Video Input Connections

If an LTC 8802 Series monitor expansion bay is supplied, each video input signal that is connected to the LTC 8801 Series main CPU bay must also be connected to the same numbered input on the monitor expansion bay.

With the LTC 8802 Series monitor expansion bay, ribbon cable connectors are provided for the video inputs. Video is to be looped from the main bay into the expansion bay through 16 LTC 8809/00 ribbon cables. Connect all LTC 8809/00 ribbon cables from the appropriate "VIDEO" ribbon cable connector on the main bay to the corresponding "VIDEO" ribbon cable connector on the monitor expansion bay. The ribbon cable connectors contain a small "key" protrusion formed into one side of the connector to assure proper placement into the mating connectors. Be careful not to force the cables into the mating connectors backwards.

IMPORTANT

The Termination DIP switches on the VIM cards installed in the main bay must be turned OFF. This will make the main bay inputs non-terminated, and the expansion bay will provide the termination for the video inputs.

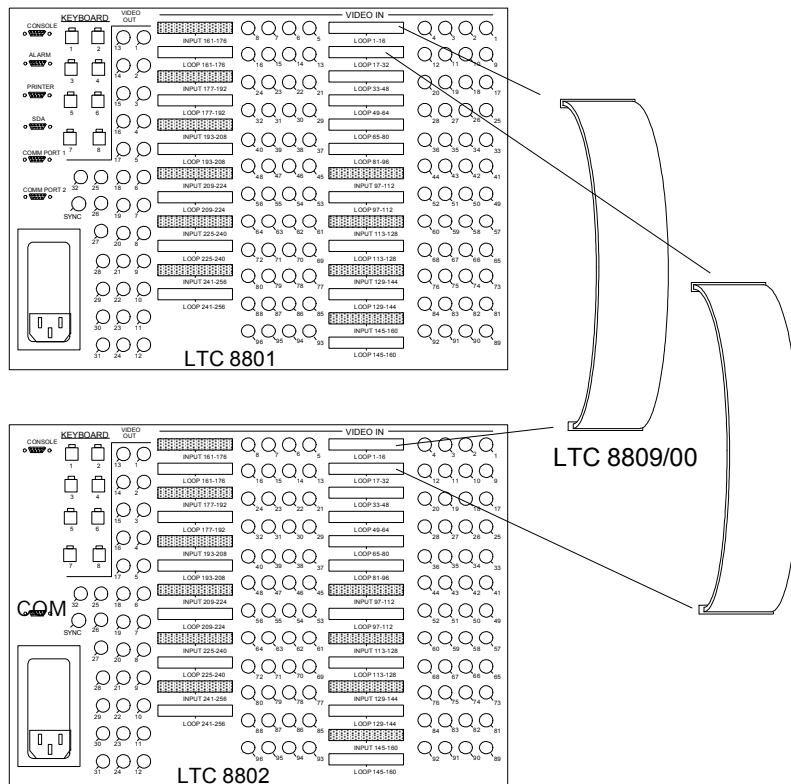

Figure 9: Typical LTC 8809/00 Cable Connections

8.6.3 LTC 8802 Series Monitor Expansion Bay Data Connections

The LTC 8802 Series Monitor Expansion Bay is supplied with a 1 m (3 ft) data communication interconnect cable. Install this cable between the Comm1 port on the LTC 8801 Series Main CPU bay, and the Comm1 port on the LTC 8802 Series Monitor Expansion Bay.

8.6.4 Monitor Output Video Connections

Just like camera inputs, monitor outputs on the Allegiant system are designed to be terminated. Each monitor output expects to be connected to a 75 ohm load. This is the regular load typically provided by a normal monitor. If a monitor output line is “looped” through several monitors or other equipment, the system installer should make sure that only the last unit on the line is terminated.

9 Optional Accessories Installation

9.1 General Accessory Installation

There are many accessory products available for the Allegiant Series, including keyboards, alarm interface units, control code signal distribution units, etc. If applicable, these products can be installed at the same time as the main CPU bay installation, or postponed until later. In some cases, products are designed to be racked in close proximity to the main CPU bay, so appropriate rack space should be reserved.

Please refer to the instructions supplied with the specific accessory product for complete installation details.

9.2 Logging Printer Option Installation

NOTE Although the exact installation procedure for each printer varies, the following steps are generally required. Be sure to save the printer reference manual for procedures not covered.

1. Switch the main power OFF to the printer.
2. Install the ribbon cartridge and paper if necessary.
3. Set any configuration switches for your particular printer to match the format provided by the Allegiant system. Note that the system communication protocol can be changed using the Keyboard User Functions (described later in this manual) or with the optional Allegiant LTC 8059 MCS package. The factory default values are as follows:

Baud rate --	115200
Stop bits --	1
Data bits --	8
Parity --	None

NOTE The required interconnect cable utilizes a custom pinout. Refer to the Appendix Section of this manual for wiring details.

4. Attach the 25-pin male D-type connector side of the RS-232 cable to the connector on the printer.
5. Attach the 9-pin male connector side of the cable to the Allegiant CPU bay connector marked "PRINTER".
6. Apply power to the printer.
7. Verify logging printer action by 'loading' a previously stored sequence into a monitor, activating an alarm, or performing a system reset. Any of these actions should cause printouts to occur.

9.3 Computer Interface Installation

NOTE Although the exact installation procedure for each computer varies, the following steps are generally required. Be sure to save the computer reference manual for procedures not covered here. Switch the main power OFF to the computer.

1. If using an Allegiant software package, attach the PC security key provided with the software to an available port on the computer.

The supplied interconnect cable utilizes a custom pinout. If it ever becomes necessary to replace the cable, it can be ordered separately using part number: LTC 8506/00. Alternatively, a cable can be configured using the information found in the Appendix Section of this manual.

2. Attach one end of the supplied RS-232 interface cable to the main Allegiant CPU bay connector marked Console (or another port that has been configured to operate as a Console port).
3. Attach the other end of the cable to an available serial port (COMM PORT 1 or COMM PORT 2) on the rear of the computer.
4. Apply power to the computer and allow it to boot up its operating system before inserting the software disc.
5. Refer to the applicable Allegiant software manual for complete programming instructions.
6. The communication settings of the PC must match those of the Allegiant. The Allegiant communication settings can be changed using Keyboard User Function 30 (described later in this manual), or may have been previously set using the Master Control Software. The factory default values are as follows:

Baud Rate	115200
Stop Bits	1
Data Bits	8
Parity	None

10 Satellite Configuration Installations

Due to the many variations possible, only general guidelines can be covered for installing satellite systems. Refer to the Appendix Section of this manual, the LTC 8850/00 GUI Software manual, or the LTC 8059/00 MCS package manual for additional configuration and programming information on satellite systems.

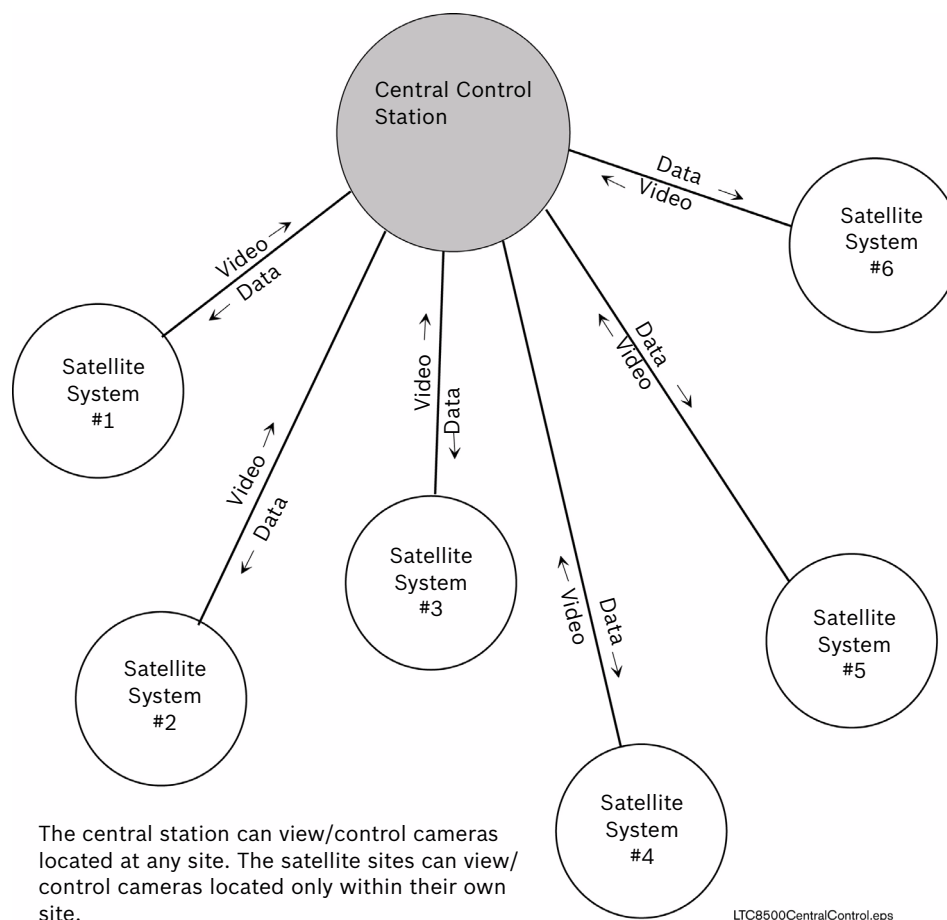

Figure 10: Satellite Concept Configuration

10.1 Satellite Site “Trunk Line” Monitor Outputs

At each of the remote satellite sites, a desired number of monitor outputs from the switcher must be assigned as trunk lines. The number of trunk lines can range from 1 to the maximum number of monitor outputs provided by the switcher. Note that the number of trunk lines coming from a satellite site determines the maximum number of cameras from that site which may be viewed simultaneously at the main site. If operators will be stationed at the satellite site, they should be prevented from accessing the monitor outputs designated as trunk lines. This prevention can be accomplished via the Monitor Lockout Tables in either the LTC 8059/00 MCS or the LTC 8850/00 GUI Software (see below).

10.2 Main Site “Trunk Line” Video Inputs

At the main site, video trunk line connections coming from each of the remote site(s) should be connected (and properly terminated) using an available video input at the main bay. There are no programming restrictions concerning their connections, but a sense of order can be maintained if a group of video inputs are used at the upper end of the system’s designed capacity. This technique allows the main system to be more easily expanded in the future with additional local cameras or trunk lines. As an example, assume there are a total of eight (8) trunk lines coming from all satellite sites which are connected to a main site system designed for 32 inputs. Inputs 25 to 32 can be reserved for the trunk lines, leaving inputs 1 to 24 for local camera connections. If there will be no local camera inputs, the trunk lines can start at the first video input.

10.3 Control Data Lines in Satellite Systems

Each satellite site must be provided with an Allegiant biphasic control data line coming from the Signal Distribution located at the main site. This data line carries all pan/tilt/zoom control commands, in addition to the switching commands generated by the main site switcher. The control data line should be connected to a LTC 8780 Series Data Converter unit, which provides address decoding functions for the satellite site. An LTC 8780 Series is required for each satellite site, and must be given a unique site address number. If operators stationed at the satellite site are permitted to control pan/tilt/zoom-equipped cameras, an LTC 8569 Series Code Merger unit must be installed at the satellite site. In order for each site to have control over pan/tilt/zoom-equipped cameras, the Code Merger combines code generated by the main and satellite sites. The LTC 8780 Series can then be connected to one of the data outputs of the LTC 8569 Series unit.

10.4 Satellite Site Programming Requirements

The optional LTC 8059/00 MCS or the optional LTC 8850/00 GUI Software is required to properly program a satellite system.

Programming the satellite sites is usually limited to designating their logical camera numbers to appropriate values via the Camera ID Table of the MCS or GUI Software. Note that no duplicate logical camera numbers are permitted anywhere in the system. Allegiant logical camera designations can be renumbered to any four-digit number on all Allegiant Series systems, except the LTC 8500 Series, which is limited to three (3) digits. Few other restrictions exist. These camera numbers are the numbers entered at both the satellite and the main site keyboards when camera selections are made. On any AutoDome Series camera or conventional pan/tilt/zoom-equipped camera, this logical number must also be entered as the receiver/driver's site address number.

The screenshot shows the 'Bosch Master Control Software For Windows' interface. The 'Camera' tab is selected, displaying a table with the following data:

Input	Camera Number	Camera Title	Installation	Bay Number	Monitor Number	Controllable
1	51	Main Entrance	Local			<input type="checkbox"/>
2	52	Lobby	Local			<input type="checkbox"/>
3	53	Hall 1	Local			<input type="checkbox"/>
4	54	Hall 2	Local			<input type="checkbox"/>
5	55	Loading Dock	Local			<input type="checkbox"/>
6	56	Parking Lot 1	Local			<input type="checkbox"/>
7	57	Parking Lot 2	Local			<input type="checkbox"/>

Figure 11: Satellite Site Sample Program Showing Logical Camera Numbers and Titles

To maintain a sense of order, it is preferable to program a satellite for a range of camera numbers. For example, in a three (3) Allegiant type satellite system, the first satellite can be programmed for camera numbers 51 to 100. Satellite two can be programmed for camera numbers 101 to 131, and satellite three can use numbers 151 to 185.

If necessary, the Keyboard-to-Monitor Lockout Table in the LTC 8059/00 MCS or the LTC 8850/00 GUI Software can be programmed in the satellite switcher to prevent any local operators from inadvertently accessing the satellite's monitor outputs being used as trunk lines.

If operators will be stationed at the satellite site, camera titles should be entered into the switcher. If desired, these titles can be selected (explained below) to appear at the main site.

The only other requirement is to ensure that the console ports of all Allegiant type satellites have been set to the correct baud rate and the handshake option disabled (CTS = off). This is done via a system keyboard (see Keyboard User Function 30), the Parameters-System screen of the LTC 8059/00 MCS or the LTC 8850/00 GUI Software (make sure CPU DIP Switch S2 is set to the ON position).

10.5 Main Site Programming Requirements

At the main site, the Camera ID Table must be programmed to ensure proper satellite operation. It is easiest to start with the trunk line inputs. For each trunk line, the satellite's monitor output number and its bay address must be entered (same number as the satellite's LTC 8780 address).

Camera numbers should be programmed next. No duplicate logical camera numbers are allowed anywhere in the entire system. If the system will include many local cameras, it is recommended to designate remote cameras (i.e., those located at satellite sites) using numbers above the main bay's physical video inputs (9+ on LTC 8100 Series, 17+ on LTC 8200 Series, 33+ on LTC 8300 Series, 65+ on LTC 8500, 129+ on LTC 8600, 257+ on LTC 8800 Series, 4097+ on LTC 8900 Series). Enter the desired camera number, (the satellite bay that it is actually connected to), and select if either a local title will be used, or if the remotely generated title will be used.

For satellite camera entries, only those numbers representing actual cameras need to be entered. For example, all 16 cameras associated with a LTC 8200 switcher do not need to be entered if only five cameras are actually connected to the switcher. If desired, a few extra camera number lines in the table may be reserved at this time for future expansion. If a local title is specified, the camera's title can also be entered at this time. Designate any local camera numbers appropriately, and enter their corresponding titles.

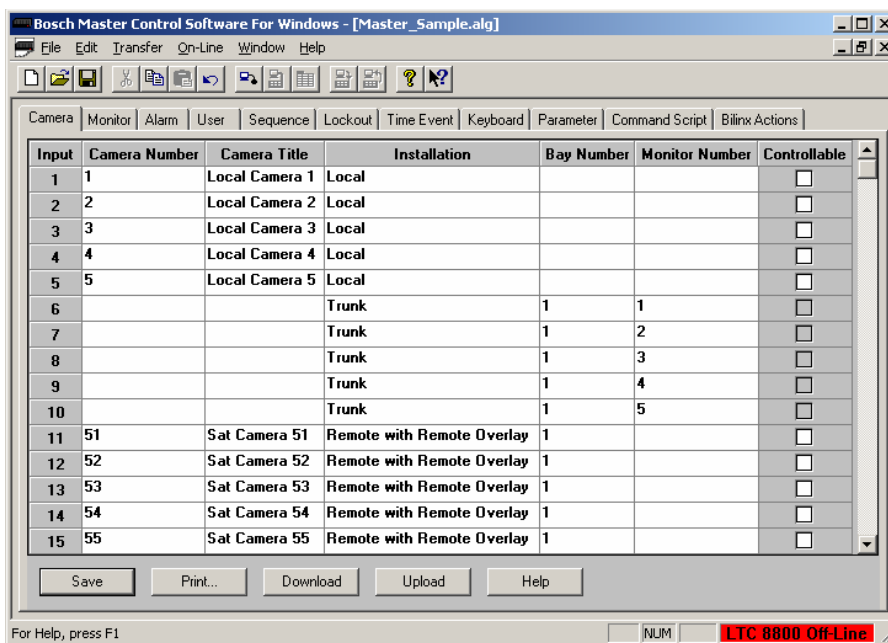

Figure 12: Main Site Sample Program Showing Local Cameras, Trunk Lines and Remote Cameras

NOTE

Either a local camera, or a remote camera programmed with a local title, will need to be selected to view certain on-screen prompts or data during programming of the main site via a system keyboard.

Once the system is programmed and configured, any unused monitor outputs located at the main site should be selected to display a local camera via the system keyboard. This prevents unused monitor outputs from using up trunk lines which may result in some confusing operational responses.

The “Start-up” camera numbers listed in the Monitor Table of the LTC 8059/00 software should be programmed to specify locally connected cameras or a local unused input (i.e., the raster generator will be displayed when called up). This table defines the camera numbers that will automatically be switched to an operator’s monitor in the event the trunk line being used to display their original satellite camera is ‘stolen’ by an operator with a higher priority.

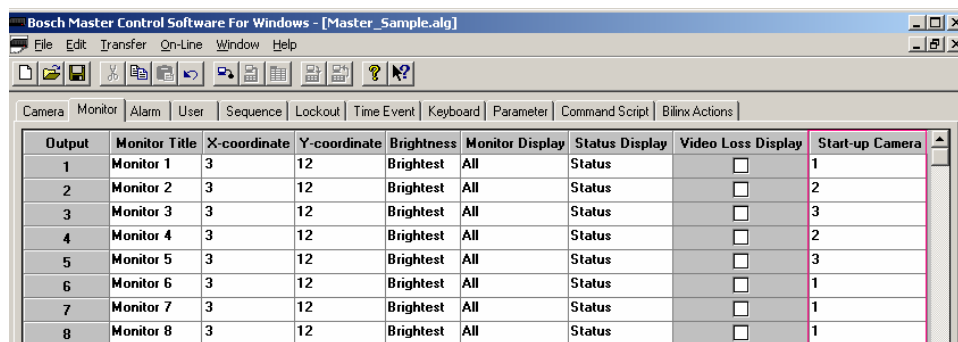

Figure 13: Main Site Sample Program Showing Monitor Start-Up Camera Numbers

10.6 Special Programming for “Cascaded” Satellite System Configurations

In a 3-tier cascaded satellite system, it is highly recommended for the system design to have more trunk lines between the intermediate master/satellite system and the 3rd level satellite system than there are between the top level master system and the intermediate system. In systems where this is not the case, it is likely that operators at top level master and the intermediate master/satellite will end up fighting for trunk lines coming from the 3rd level satellite system.

There are two user configuration options available (starting in CPU firmware version 8.70) to eliminate or at least significantly reduce conflicts between operators when this type of system is being used.

Option 1: Using Factory default settings, previously selected satellite cameras remain on trunk lines even after the operator switches back to a local camera view. Although this mode of operation is more desirable in standard systems because it minimizes delays when previous satellite cameras are reselected, it is not advantageous to use in cascaded systems. In cascaded systems, all available trunk lines coming from the 3rd level satellite system may become used up, making them unavailable to the operators at the intermediate system.

In this situation, keyboard User Function 41 should be set to the NO REM CAM CACHE option at the master site location. In this mode, after the top level operator selects a locally connected camera, the trunk line between the top level and the intermediate level system will immediately be reset to its Start-up camera (as defined in the Monitor Table of the LTC 8059/00 MCS). This action frees the trunk line between the intermediate level system and the 3rd level system so it will be available if needed by an operator at the intermediate level system.

For the monitors being used as trunk lines in the intermediate system, it is important for the “Start-up” camera numbers listed in the Monitor Table of the LTC 8059/00 software to be programmed to specify cameras connected locally or a local unused input (i.e., the raster generator will be displayed when called up). This action ensures that no trunk line is used when a monitor switches to the Start-up camera.

Option 2: If the top level master system and intermediate level system in a cascade configuration can or will be set to operate as “Dual Master” systems, a priority based satellite camera feature can be configured.

In default cascaded satellite system configurations, satellite switching commands are not associated with a user priority level. When a switching command sent from a master site is received by a satellite, the switch selection can immediately be overridden by operators at the satellite location who have any priority level. This situation is more likely to be encountered in 3-tier Satellite systems that do not have a good distribution of trunk lines (i.e., more between the top level system and the intermediate level system than there are between the intermediate system and the 3rd tier satellite).

Since dual master configurations support bi-directional communications, it is possible to set keyboard User Function 41 to use the SAT nnn PRIORITY option for both the top level and intermediate level master systems. The satellite number assigned to the system that is currently being programmed must be specified here. This feature will enable use of the operator’s user priority to determine if access to a desired satellite camera is provided or not. For instance, if no trunk lines are available and an operator requesting a satellite camera has a higher priority than at least 1 of the existing operators, the requested camera will be switched. If the operator does not have sufficient priority, they will receive an error message (i.e., error 81) via the satellite communication path, and their camera will switch to the Start-up camera specified in the Monitor Table.

10.7 Alarm Inputs in Satellite Systems

Any alarm inputs to the main site, which have been programmed to activate cameras located at satellites, will operate normally except when limited by the number of trunk lines available. The software automatically determines trunk usage depending on the priority level of operators currently viewing satellite cameras. Alarm inputs applied at a satellite site will not activate the alarm video at the main site. If the application requires alarms located at a satellite to activate video at the main site, the remote alarms must be brought back to the main site. If necessary, the main site's LTC 8540/00 Alarm Interface unit can be remotely located via an RS-232 link. Since the Alarm Interface capability is an integral part of the LTC 8100, LTC 8200, and LTC 8300 Series, this is not possible if an LTC 8100, LTC 8200, or LTC 8300 Series system is being used as the main site system. If more than one satellite site contains alarms, multiple LTC 8540/00 Alarm Interfaces can be remotely located. The number of alarm interfaces which can be remoted is limited only by the capacity of the main site system to support this capability.

11 Feature Selection

Certain user-selectable features can provide enhanced Allegiant system operation capabilities. Any desired changes can be made now or delayed until specific system requirements become more apparent. Refer to the Factory Default Settings Section for a full description of these features and selection instructions.

12 Main Power Connections

1. Attach the supplied AC power cord(s) between the bay(s) and appropriate AC power source. Verify that power supply is configured for desired voltage input. If necessary, instructions for changing the input voltage selection can be found in the Maintenance section of this manual (See Chapter 19, "Maintenance Information," on page 83) Switch power ON to the bay(s). In multibay systems, the bays can be powered up in any order.

NOTE The system may require several seconds to fully initialize after a power-up reset. Up to one (1) minute may be required before a LTC 8802 Series Monitor Expansion bay fully initializes. This time can vary based on the activity and general size of the system.

2. Verify that the LEDs associated with the fuses are lit on all of the applicable power supplies.

NOTE Upon power-up, the system monitors may momentarily display video output module software version information.

Installations having cameras powered from an AC phase different than that of the Allegiant system may utilize the built in EXTERNAL SYNC input or vertical PHASE ADJUST.

NOTE All cameras should be phased properly with each other before the EXTERNAL SYNC or PHASE ADJUST feature is implemented.

The EXTERNAL SYNC input will accept composite video, composite sync, or output from a Master Sync generator. Any one of the phased cameras may be used as a master sync source to the system using the EXTERNAL SYNC input. To implement this feature, simply connect the incoming video source (using a BNC "T" connector) to both the appropriate camera BNC input and the EXTERNAL SYNC input which is found on the rear of the Allegiant CPU bay. The front panel illuminates the EXT SYNC LED. Alternatively, the PHASE ADJ on the front panel of the power supply may be adjusted until the vertical interval switching is achieved. The PHASE ADJUST has a range of about 130 degrees.

3. Reattach the front panel(s) to the bay(s).

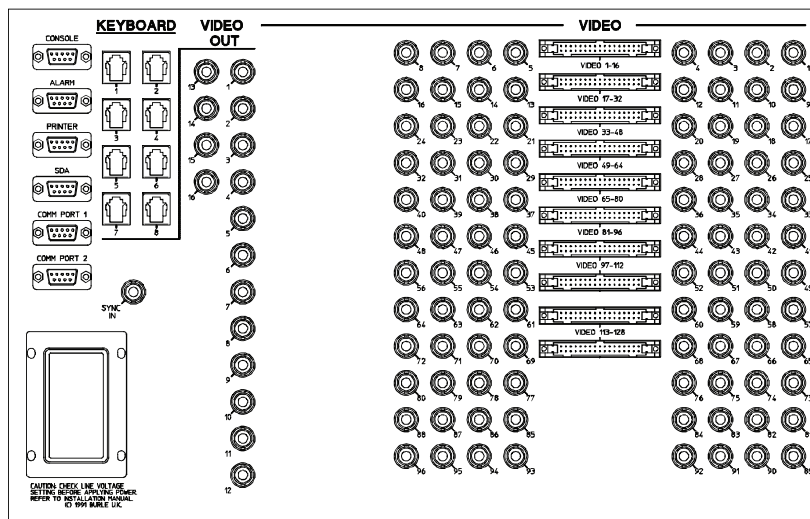

Figure 14: LTC 8600 Series Rear Panel



Figure 15: LTC 8808/00 Video Interconnect Panel

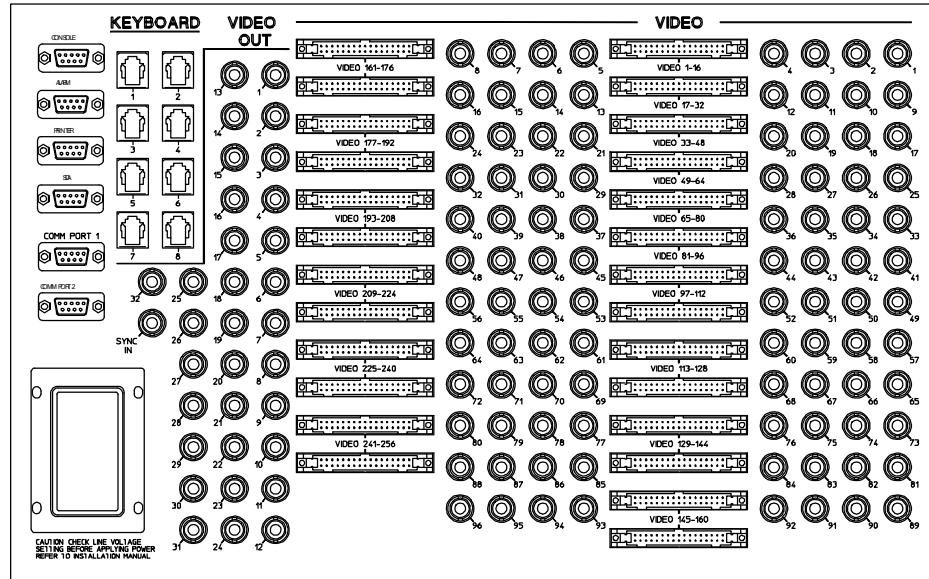

Figure 16: LTC 8801 Series Main CPU Bay Rear Panel

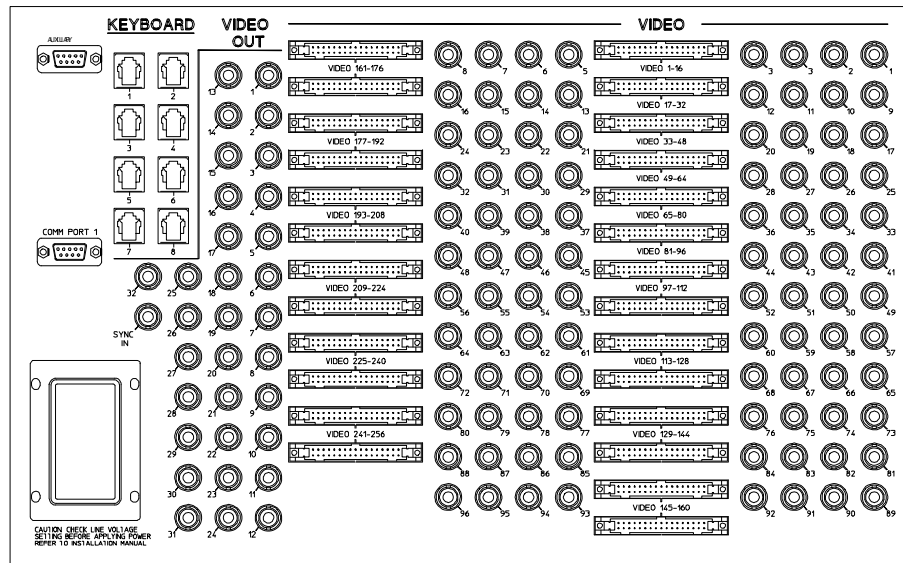

Figure 17: LTC 8802 Series Monitor Expansion Rear Panel

13 Video Monitor Display

The Allegiant Series systems feature an integral text overlay with two or three rows of 24 characters each. There are over 2000 different characters that can be displayed. See Chapter 20, “Character ROM Tables for LTC 8600 and LTC 8800,” on page 86

NOTE If no video signal is present, a new line will appear stating: VIDEO NOT PRESENT. The display is broken down into seven areas as shown in the figure

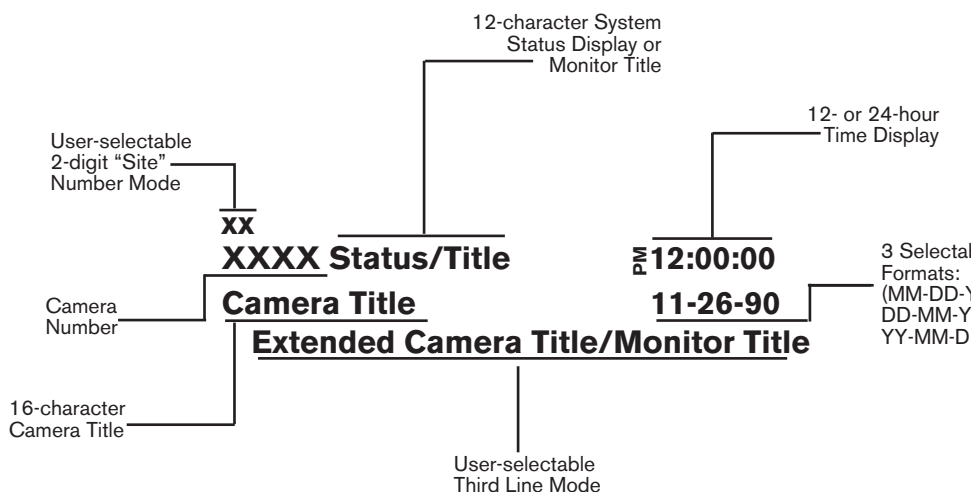

Figure 18: Monitor Overlay Display

NOTE The Monitor Overlay Display shows all six digits including leading zeros for a camera number in 6-digit mode. In 4 digit mode, the camera number display depends on the setting of the Miscellaneous Parameter option as set in the Master Control Software.

13.1 Time/Date

The time/date display is generated by the system CPU microprocessor module. It is crystal controlled and battery protected for one year (minimum) without power. The display is updated once per second and all monitors update simultaneously. The time/date message is always on the right side of the video display with the time on the top line. Time displays hours, minutes, and seconds, and can be set to either 12-hour or 24-hour operation. The date is available in three (3) user-selectable formats:

1. U.S. Format - The order for the American date display is: MM/DD/YY. (Default for 120 VAC systems)
2. International Format - The order for the international date display is: DD/MM/YY (Default for 220-240 VAC systems)
3. Asian Format - The order for the Asian date display is: YY/MM/DD

13.2 Monitor Title/System Status Display

The monitor title/system status display area is a 12-column display to the right of the camera number. It is unique on each of the monitors. It has different uses, some of which may be selected by the user at a keyboard location. The various uses are described below.

13.2.1 System Status Display

If this display is selected (factory default), it allows the Allegiant system to dynamically inform the user of the system status. The 12-column display is divided into smaller message columns (see figure below), in which special characters inform the user of the following:

- if the switcher is running or stopped
- the switcher's direction
- if a monitor or remote camera is locked
- the alarm status of the camera and monitor.

13.2.2 Locations 1, 2, and 3 - Alarm Indication

When the monitor overlay is in the status display mode, locations 1 through 3 indicate if a camera on the monitor is in the alarm mode. If the on-screen camera is currently in alarm mode, an ALM message will flash in a box at this location mode. If no cameras are currently in alarm mode on this monitor, these spaces are blank. Note that when a monitor has cameras in alarm mode, pressing [NEXT], [RUN], or [PREVIOUS] on the keyboard will move you through the alarm sequencer rather than the regular camera sequencer. The alarm switcher status will be displayed in location 6 using described symbols.

13.2.3 Location 4 - Monitor Arm Status Indication

In the MONITOR ARMED location, the characters SM or DM will appear if the monitor is armed for alarm. SM means that the monitor is a "step" or "sequence" monitor, and will automatically step through multiple alarm videos. DM indicates that the monitor is a "display" or "review" monitor, which will collect alarm videos from one or more step monitors.

When an alarm occurs, the alarmed camera's video will replace the current display of the monitor. If the monitor is not armed, this location will be blank.

13.2.4 Location 5 - Camera Arm Status Indication

In the CAMERA ARMED location characters CA are displayed if the camera being viewed is armed for alarm on that monitor. If the alarm signal associated with this camera becomes active, the camera will be displayed on the appropriate armed monitors.

13.2.5 Location 6 - Error Indication

This location is used to indicate an error on the part of the user. When a user error occurs, this location will display an ERR symbol. The specific error number will appear in locations 7 and 8. The error number will also appear in the Camera Number Display field on the keyboard. The display will return to normal after a few seconds have passed, or if the user presses [Enter] on the keyboard.

Location 6 is also used to indicate the sequencing direction when alarms occur. One of four of the following character combinations will be displayed:

- a. \hat{R} indicates the alarms are sequencing in a forward direction.
- b. $R\hat{V}$ indicates the alarms are sequencing in a reverse direction.
- c. \hat{S} indicates the sequencing of alarms has stopped, but if started again would sequence in a forward direction.
- d. $S\hat{V}$ indicates the sequencing of alarms has stopped, but if started again would sequence in a reverse direction.

Location 6 can also be used to display a symbol to indicate pan/tilt/zoom equipped cameras. Using the keyboard (see User Function 35), or the optional LTC 8059/00 MCS, controllable cameras can be individually selected to display a “<|>” symbol in location 6 whenever they are viewed on a system monitor.

13.2.6 Location 7 - Remote Lock Indication

This location will display characters RL to indicate that control over the movements of the camera being viewed have been “locked” by a user. Control over this camera is now possible only by the user who locked the camera or by a user with higher priority. If the camera is not locked, the icon will not be displayed. If a user error has occurred, this location will temporarily hold part of the error number.

13.2.7 Location 8 - Monitor Lock Indication

This location will display characters ML to indicate that the monitor has been “locked” by a user. The camera currently being viewed can not be changed except by the user who locked the monitor or one with higher priority. If the monitor is not locked, the icon will not be displayed. If a user error has occurred, this location will temporarily hold part of the error number.

13.2.8 Location 9 - Sequence Type Indication

This location is used to display the type of sequence currently “loaded” on the monitor. An “absolute sequence” is indicated by the characters $\overset{A}{S}$ which means that the monitors programmed in the sequence program refer to the exact monitor(s) from which the sequence may be run. Sequences created using the system keyboards are always of this type, so absolute sequences are the only type possible in a base system. Sequences designated as “relative sequences” are designated by the characters RS in this location. These sequences run on any monitor or group of monitors and can be programmed only using the optional LTC 8059/00 MCS package or the optional LTC 8850/00 GUI Software package with a personal computer.

13.2.9 Locations 10 and 11 - Sequence Number

The sequence number currently active for the monitor is displayed in these two locations. This number is between 1 and 60, or 00 to indicate that no sequence is loaded.

13.2.10 Location 12 - Sequence Status Indication

This location indicates the status of the sequence “active” in the monitor. There are four possible character combinations:

- a. \hat{R} indicates the current sequence is sequencing in a forward direction.
- b. $\overset{R}{V}$ indicates the current sequence is sequencing in a reverse direction.
- c. \hat{S} indicates the sequence is stopped, but if started again would sequence in a forward direction.
- d. $\overset{S}{V}$ indicates the sequence is stopped, but if started again would sequence in a reverse direction.

13.3 Monitor Title

The monitor message is a stationary 12-character title which may be placed on a monitor instead of the system status display. A specific monitor message can be programmed using the keyboard (see User Function 17), the optional LTC 8059/00 MCS package, or the optional LTC 8850/00 GUI Software package.

1	2	3	4	5	6	7	8	9	10	11	12
A	A	A	M	C	E	R	M	A	S	S	S
l	l	l	o	a	r	e	o	b	e	e	e
a	a	a	n	m	r	m	n	s	q	q	q
r	r	r			o			/			
m	m	m	A	A	r	L	L	R	N	N	S
			r	r	/	o	o	e	u	u	t
			m	m	D	c	c	l	m	m	a
					l	k	k				
					R						
					vw						

Table 1: Format of Monitor Overlay's System Status Display

13.4 Broadcast Message

The operator of the personal computer can send a message using the optional LTC 8059/00 MCS package or the optional LTC 8850/00 GUI Software package to all the monitors in the system. This message may be up to 24 characters long, and can be used to notify all users at all monitor locations of important information. The message, along with its beginning and ending time and date, is also printed out on the logging printer, if one is connected; and any acknowledgment from users is also recorded. The broadcast duration may be set for 1 to 60 seconds. The message is displayed on a line by itself.

13.5 Program Prompts

During entry of sequence programming using the keyboard, the Allegiant system prompts the user on the monitor his keyboard is currently “controlling”. The display will return to its previous form when the user leaves the programming mode.

13.6 Camera Number

The left-most display on the top line shows the camera number. This number is generated by the system and is always displayed. Each number is unique and identifies this camera when using the keyboard for video call-ups.

In base systems, this number is the same as the numbered BNC connector that the camera is plugged into on the rear of the bay (physical camera number). However, the optional LTC 8059/00 MCS package or the optional LTC 8850/00 GUI Software package can be used to change this number to any unique number between 1 and 9999.

The option to display a 2-digit site number above the 4-digit camera number is user-selectable. This “6-digit Camera ID” mode is especially useful when groups of cameras are located in separate buildings, floors, or other common areas.

13.7 Camera Title

The camera identification display is the first 16 characters of the lower line. These 16 characters label each camera. Each camera has its own title, which is displayed whenever that camera is called-up for viewing. The characters can be entered from the keyboard (see User Function 9) or may be entered from the personal computer keyboard using the optional LTC 8059/00 MCS package or the optional LTC 8850/00 GUI Software package. A user selectable option provides the ability to display a 3rd line of on-screen text. This third line can be configured to display up to 24 additional camera title characters (40 characters total) or a 12-character monitor title. There are over 4000 different characters that can be displayed. See Chapter 20, “Character ROM Tables for LTC 8600 and LTC 8800,” on page 86.

13.8 Video Loss Detection

The Allegiant system is capable of detecting loss of video. When the unit detects lost video, the respective monitor display a VIDEO NOT PRESENT message.

NOTE It may take up to five (5) seconds for the unit to display the video loss message when a video source is disconnected.

14 Factory Default Settings

As the Allegiant system is shipped from the factory, certain features are placed in a default configuration. The installer can select some of these features at the time of system installation/configuration. Generally the default configuration represents the simplest mode of operation, allowing the user to become familiar with the system before any advanced features are selected. The default settings are described in the sections below.

14.1 User Selectable DIP Switch Settings for Main CPU Bay

NOTE After changing any of the following switches, the system must either be powered OFF and ON or reset using the keyboard (see user function 15).

14.1.1 Upper CPU DIP Switch S1

System CPU modules contain three (3) 8-position DIP switches. The settings of the upper DIP switch do not need to be changed from their factory default positions except when using a Console Port Expander accessory unit or if a problem is encountered when downloading new firmware into the CPU. For reference, the functions are as follows:

DIP Switch Number	Factory Default Setting	“Upper” S1 DIP Switch Function
1	OFF	Not Used
2	OFF	Not Used
3	OFF	Console Expander Use
4	OFF	Console Expander Mode
5	OFF	Boot Mode
6	OFF	Not Used
7	OFF	Not Used
8	OFF	Not Used

- Switch 1 and 2 of S1
These switches are not used in these systems and should be left OFF.
- Switch 3 of S1
This switch should be set to ON if an LTC 8712 Series Console Port Expander is connected to the Allegiant’s console port. This selection can also be set using either the MCS or the PC-based GUI Software package.
- Switch 4 of S1
Use this switch to set the communication baud rate that the Allegiant will use when connected to a LTC 8712 Series Console Port Expander. It is only applicable when DIP switch 3 is in the ON position. When set to ON, the baud rate will be 57,600 bps (recommended setting). When OFF, the baud rate follows the setting determined via DIP switch 8 of the lower CPU DIP switch. If switch 8 of the lower DIP switch is OFF, the baud rate defaults to 19,200 bps. If switch 8 of the lower DIP switch is ON, the user programmed baud setting is used, but the user setting must be 19,200 baud or higher in order to operate.
- Switch 5 of S1
In the ON position, this switch is used to force the CPU into a “boot” mode so it is ready to accept a download of an operating system program via its console port. This setting should not be changed unless a problem has been encountered while attempting to download a new operating system program. When this mode is enabled, the baud rate is fixed to 115200 and hardware handshake is ON.
- Switch 6, 7, and 8 of S1
These switches do not currently provide user selectable options and should be left OFF.

14.1.2 Middle CPU DIP Switch S2

The middle DIP switch provides several user-selectable options. These options are as follows:

DIP Switch Number	Factory Default Setting	“Middle” S2 DIP Switch Function
1	OFF	Reserved
2	OFF	Alarm Port Mode
3	OFF	Old Keyboard Modes
4	OFF	Printer Port Mode
5	ON	Security Feature
6	OFF	Not Used
7	ON	Keyboard Protocol Mode
8	ON	Communication Parameters

- Switch 1 of S2

This switch is not used in these systems and should be left OFF.

- Switch 2 of S2

If switch 2 is turned ON, the alarm port on the rear of the main Allegiant bay is configured as an auxiliary console port. This auxiliary port allows the alarm port (in addition to the regular console port) to communicate with the optional LTC 8059/00 MCS package or the optional LTC 8850/00 GUI Software package.

The port can also be used to control the Allegiant system via the Console Command Language (documented in the optional CCL manual). The normal console port and the alarm port (when switch 2 is on) may be used to control the Allegiant system simultaneously. Communications parameters (baud & handshake) for the alarm port can be set using the keyboard (see User Function 32), with the optional LTC 8059/00 MCS package or with the optional LTC 8850/00 GUI Software package.

Note that the pin-out of the alarm port differs from that of the console port, so the cable supplied with the optional LTC 8059/00 MCS package or with the optional LTC 8850/00 GUI Software package can not be used when interfacing with the alarm port. If necessary, See Chapter Appendix D, “Main Bay Rear Panel Connector Pin-outs,” on page 117 for the alarm port pin-outs.

- Switch 3 of S2

This switch setting is ignored if DIP switch 7 (described below) is set to ON. Current systems utilize a “variable speed” keyboard communication protocol. Older systems and keyboards were limited to using “fixed speed” keyboard communication protocols. In addition, there were two types of fixed speed protocols available. By default, newer CPUs are set to operate using “six poll byte” variable speed mode, but if a newer CPU is installed into an older system, the existing keyboards would not operate with this format. This option switch is provided to support backward compatibility with the older style keyboards.

When this switch is set to OFF, the CPU in an LTC 8600 Series system communicates with the system keyboards using a “four poll byte” protocol when this switch is OFF. When it is on, the keyboard communication uses an “eight poll byte” protocol. For LTC 8800 Series systems, the settings are reversed: “eight poll bytes” when OFF, “four poll bytes” when ON.

This option is a global system setting that determines the communication protocol that will be used for all keyboards connected to the system.

For reference, the following table lists the Allegiant Series keyboard models and the protocol supported by each:

Keyboard model	Supported protocols
TC8550KB	4 poll byte
TC8550KB-8	8 poll byte
TC8550	4 or 8 poll byte
TC8550A, TC8551A, TC8553	4, 6, or 8 poll byte
TC8554, TC8555	4, 6, or 8 poll byte
LTC 8553 Series	4, 6, or 8 poll byte
LTC 8555 Series	4, 6, or 8 poll byte
IntuiKey KBD-Universal	6 poll byte

- Switch 4 of S2

This switch allows the printer port on the rear of the main Allegiant bay to be configured as an auxiliary console port when it is turned ON. See the description above regarding switch 2 for information on using an auxiliary console port. The printer port has the same pin-out as the normal console port, so the console cable supplied with the optional LTC 8059/00 MCS package or with the optional LTC 8850/00 GUI Software package may be used to interface with the printer port when switch 4 is ON. Communication parameters (baud & handshake) for the printer port can be set using a keyboard (see User Function 31), or with the optional LTC 8059/00 MCS package or with the optional LTC 8850/00 GUI Software package.

NOTE This feature can also be implemented via the **PRT2CON** CCL command using an external PC, dumb terminal or other computing device. Refer to the Allegiant Command Console Language (CCL) manual for complete information about using CCL commands.

- Switch 5 of S2

This switch controls the system security modes. When this switch is set to ON, the system log-in features can be controlled using keyboard User Function 27 and User Function 28 (refer to the section on Keyboard User Functions for complete information). Users with Priority 1 can access keyboard User Function 27 to select if the system keyboard log-in feature is enabled or disabled. When enabled, the system keyboards require each user to log-in to the system and to log-off the system. All users are required to enter a user number and the correct password before the system permits interaction.

Users with Priority 1 can also access User Function 28 to select if the console port log-in feature is enabled or disabled. When enabled, any external PC or other computing device is required to log-in to the system and to log-off the system. All users are required to enter a user number and the correct password before the system permits interaction.

If this switch is turned OFF or if the features are disabled using User Functions 27 and 28, the system keyboards and the console port are always online with the system.

NOTE When changing from the no 'log-on' mode to the 'log-on' mode, all system keyboards are initially 'logged-off'.

- Switch 6 of S2
This switch is currently not used and should be left OFF.
- Switch 7 of S2
This switch controls the system keyboard polling mode. When switch 7 is ON (factory default), the CPU communicates with all system keyboards via a “6 poll byte” communication protocol. This format provides variable speed pan/tilt control for AutoDome-equipped camera sites. Refer to the information for Switch 3, above, for more details.

NOTE The variable speed mode is not compatible with the pre-1996 TC8561 receiver/drivers without using an LTC 8785 Series code converter unit.

Dip switch 7 can be turned OFF (usually at system installation) to allow operation with the older fixed speed-only type keyboards that are able to communicate only using the older format. In this mode, the system can communicate with the older TC8561 Series of receiver/drivers without using the LTC 8785 code converter unit. Note that the fixed speed keyboard mode allows access to only the first 63 auxiliary and pre-position functions. This is not an issue on older receiver/driver versions, but may pose a problem if the system must be expected to access all functions available in the AutoDome Series of pan/tilt/zoom dome cameras or the higher preposition numbers in current versions of Allegiant receiver/drivers.

- Switch 8 of S2
This switch controls the protocol settings of the external RS-232 port which connect to the Console, Printer, and Alarm.

If the switch is turned OFF, the system uses the factory default settings for the RS-232 data communication protocols as listed below.

With switch 8 ON, any RS-232 port protocols changed using the keyboard (see User Function 30), the optional LTC 8059/00 MCS package, or the optional LTC 8850/00 GUI Software package are active.

Users with Priority Level 1 can also use the keyboard (see User Function 29) to reset any changed protocols back to the default settings (see below).

Switch 8 also controls the activation of a “boot screen” Command Script program previously downloaded into the CPU's memory. Command Scripts are user-defined programs designed to provide special system functions or features at system startup or reset. If the switch setting is OFF, any existing boot screen function will not be activated.

The default (DIP switch 8 OFF or after activation of Keyboard User Function 29) data communication settings for the Allegiant system are listed below.

Settings	Console Port	Printer Port	Alarm Port	Keyboard Ports
Baud Rate	115200	115200	19,200	9600
Stop Bits	1	1	1	--
Data Bits	8	8	8	--
Parity	None	None	None	--
Handshake	Yes	No	No	--

14.1.3 Lower CPU DIP Switch S3

The lower CPU dip switch does not currently provide any user selectable options, and all settings should be left in their OFF position.

14.2 User Selectable DIP Switch Settings for LTC 8816/00 Data Receiver Modules used in LTC 8802 Series Monitor Expansion Bays

NOTE After changing any of the following switches, the system must be powered off and on using the LTC 8802 Series monitor expansion main power switch.

14.2.1 Upper Data Receiver DIP Switch S1

LTC 8816/00 data receiver modules supplied in the LTC 8802 Series bays contain three (3) 8-position DIP switches. The settings of the upper DIP switch do not need to be changed from their factory default positions except when it is necessary to change the factory default format for the internal raster generator or if a problem occurs downloading new firmware into the data receiver module. The following table list these functions:

DIP Switch Number	Factory Default Setting	“Upper” S1 DIP Switch Function
1	ON/OFF	Raster Generator Mode
2	OFF	Not Used
3	OFF	Not Used
4	OFF	Not Used
5	OFF	Boot Mode
6	OFF	Not Used
7	OFF	Not Used
8	OFF	Not Used

- Switch 1 of S1
This switch selects the frequency of the internal raster generator used for display of on-screen text during video loss conditions. When set to OFF, the raster is generated at 60 Hz (default for 120 VAC models). When ON, the raster is generated at 50 Hz (default for 220-240 VAC models). To set the DIP switch changes, power the unit OFF and then turn the unit ON.
- Switch 2, 3, and 4 of S1
These switches are not used in these systems and should be left OFF.
- Switch 5 of S1
In the ON position, this switch forces the data receiver into a “boot” mode so it can accept a download of an operating system program via its console port. When this mode is enabled, the baud rate is fixed to 115200 and hardware handshake is ON.
- Switch 6, 7, and 8 of S1
These switches do not currently provide user selectable options and should be left OFF.

14.2.2 Middle Data Receiver DIP Switch S2

The lower DIP switch provides certain user-selectable options. These options are as follows:

DIP Switch Number	Factory Default Setting	S2 DIP Switch Function
1	OFF	Reserved
2	OFF	Keyboard Group
3	ON	Keyboard Group
4	OFF	Reserved
5	OFF	Reserved
6	ON	Keyboard Mode
7	ON	Operational Mode
8	OFF	Operational Mode

- Switch 1 of S2
This switch is reserved and should be left OFF.
- Switch 2 and Switch 3 of S2
Up to eight (8) system keyboards can be connected to the rear panel of the LTC 8802 Series Monitor Expansion Bay. DIP switches 2 and 3 determine the system keyboard group that can be assigned. Follow the table below to select the desired group.

Switch 2	Switch 3	Keyboard Group
Off	Off	Reserved
Off	On	Keyboards 9-16 (Default)
On	Off	Keyboards 17-24
On	On	Keyboards 25-32

- Switch 4 and Switch 5 of S2
These switches are reserved and should always be left OFF.
- Switch 6 of S2
When switch 6 is ON, the LTC 8816/00 data receiver module communicates with system keyboards using the newer “6 poll byte” protocol. This format is required to provide variable speed pan/tilt control capability for AutoDome equipped camera sites. If it is necessary to communicate to older system keyboards that are only compatible with fixed speed keyboard protocols, place the switch in the OFF position.
- Switch 7 of S2
This switch determines the operational mode of the LTC 8816/00 and must always be left ON.
- Switch 8 of S2
This switch determines the operational mode of the LTC 8816/00 and must always be left OFF.

14.2.3 Lower Data Receiver DIP Switch S3

- The lower DIP switch does not currently provide any user-selectable options, and all settings should be left in their OFF position.

15 User Information

15.1 User Priority Levels

There are eight (8) levels of user priority in the Allegiant system. Each of the 32 users in the Allegiant system has a default priority level assignment. These user levels determine access to various system functions and provide a means to prioritize user control of monitors and pan/tilt/zoom equipped camera sites. Generally, users with higher priority (highest = 1) can regain control over monitors or pan/tilt/zoom cameras 'locked' by another user.

User Number	Default Password	Priority Level	Default Keyboard
1	1	1	1
2	2	2	2
3	3	2	3
4	4	2	4
5	5	8	5
6	6	8	6
7	7	8	7
8	8	2	8
9	9	2	9
10	10	2	10
11	11	2	11
12	12	2	12
13	13	2	13
14	14	2	14
15	15	2	15
16	16	2	16
17	17	2	17
18	18	2	18
19	19	2	19
20	20	2	20
21	21	8	21
22	22	8	22
23	23	8	23
24	24	8	24
25	25	8	25
26	26	8	26
27	27	8	27
28	28	8	28
29	29	8	29
30	30	8	30
31	31	8	31
32	32	8	32

The table above shows the default values of a base system. The 8 priority level user assignments can be changed using the optional LTC 8059/00 MCS package or the optional LTC 8850/00 GUI Software package. Note that in base systems where the keyboard log-in feature has not been selected, a user number is automatically assigned to a specific keyboard port. In this mode, setting the priority of the default user essentially determines the priority level of the keyboard during operation. Also shown in the table is the default user passwords assigned to each user as the system is shipped from the factory. Once a user is logged into the system, the pass-

word can be changed using the keyboard (see User Function number 10). Refer to the specific section of the operation instructions for exact procedures of using keyboard User Functions. Although the table indicates 32 possible users, only 16 keyboards are supported in LTC 8600 Series systems.

15.2 User Priority Access Table

The following table shows system function access as it applies to the eight (8) levels of users.

System Function	Priority Level		
	1	2 to 7	8
Switch Video On Monitors	Yes	Yes	Yes
Control Pan/Tilt/Zoom Camera	Yes	Yes	Yes
Lock Monitor	Yes	Yes	Yes
Lock Pan/Tilt/Zoom Camera	Yes	Yes	Yes
Acknowledge Alarms	Yes	Yes	Yes
Perform Keyboard Test	Yes	Yes	Yes
Show Keyboard Number	Yes	Yes	Yes
Activate Keyboard Beeper	Yes	Yes	Yes
Change User Password	Yes	Yes	Yes
Program Sequences	Yes	Yes	No
Position Video Overlay Display	Yes	Yes	No
Set Overlay Display Brightness	Yes	Yes	No
Select Overlay Display Type	Yes	Yes	No
Set System Time/Date	Yes	Yes	No
Program Pre-positions	Yes	Yes	No
Set Time/Date Format	Yes	No	No
Set Camera and Monitor Titles	Yes	No	No
Enable 3-Line Title Mode	Yes	No	No
Enable 6-Digit Camera ID Mode	Yes	No	No
Camera Vertical Phase Set	Yes	No	No
Enable Time Events	Yes	No	No
Reset System	Yes	No	No
Printout Tables and Sequences	Yes	No	No
Default Monitor Overlay	Yes	No	No
Select Alarm Response Mode	Yes	No	No
Select Printer Mode	Yes	No	No
Designate Alarm Monitor Type	Yes	No	No
Select Keyboard Log-in	Yes	No	No
Select Console Log-in	Yes	No	No
Configure/Reset RS-232 Ports	Yes	No	No

16 Alarm Information

16.1 General

The ability to automatically switch video in response to an external signal (usually a contact closure) is a necessary feature in any video switching system. The Allegiant system permits users with Priority Level 1 to select any 1 of 3 predefined alarm response modes (via keyboard User Function 19). A description of these three (3) modes appears below. Pictorial examples of the three (3) alarm responses are also shown on the following pages.

The system can also be programmed with a wide variety of alarm response characteristics using the optional LTC 8059/00 MCS package or the optional LTC 8850/00 GUI Software package.

16.2 Basic Alarm Response Mode

In the Basic alarm response mode, any or all of the monitors can be selected as alarm display monitors. Each alarm can then be armed to display its camera(s) on any set of armed monitors. Multiple alarms, on the same monitor, will sequence at a 1 second rate. Note that monitors and alarms can be armed and disarmed individually as required. Alarmed video automatically clears when the alarm input signal is reset.

16.3 Auto Build Alarm Response Mode

This mode uses a set of monitors as alarm display monitors. All system monitors may be armed if desired. Each triggered alarm will display its alarm video on a different monitor, starting with the lowest numbered armed monitor. If all the armed monitors are already displaying alarm video, subsequent alarms will build on the existing alarmed monitors; and each monitor will sequence through its alarm videos at a 1 second rate. Note that monitors and alarms can be armed and disarmed individually as required. Alarmed video will automatically clear when the alarm input signal is reset.

16.4 Sequence and Display Alarm Response Mode

This mode designates two monitors as alarm response monitors. Monitor #1 is the DISPLAY monitor (also called a REVIEW monitor) and monitor #2 is the SEQUENCE (or STEP) monitor. The first alarm appears on both monitors and additional alarms begin to sequence at a 1 second rate on the SEQUENCE monitor. The DISPLAY monitor holds the first alarmed camera video until manually acknowledged through the keyboard. When the first video is cleared from the DISPLAY monitor, the next alarmed video ("next" meaning the camera that enters an alarmed state second) is displayed until cleared; operation continues in this manner. Note that alarms can be armed and disarmed individually as required. Note also that all alarms must be manually cleared; the presence of alarm video is not dependent upon the duration of the alarm input signal to the system.

16.5 Alarm Activated Pre-position

Alarm activated pre-position capability exists in each of the three (3) alarm response modes. This enables a pan/tilt/zoom equipped camera to automatically position itself to a preprogrammed scene as a result of an alarm signal. When using conventional pan/tilt equipped devices and zoom lenses, they must have the necessary options for pre-position control. The system default is to activate pre-position #16 of the system camera receiving an alarm. Using the optional LTC 8059/00 MCS package or the optional LTC 8850/00 GUI Software package, the user can configure a response to alarms as required.

16.6 Sample Alarm Responses

Basic Mode

In the Basic alarm response mode, cameras are individually armed for each alarm monitor.

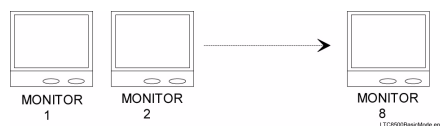

Alarm Status	Alarm Station Display
1 st Alarm	Video associated with 1 st alarm is displayed on any or all appropriately armed monitors.
2 nd Alarm	Video associated with 2 nd alarm is displayed on any or all appropriately armed monitors.
3 rd Alarm	Video associated with 3 rd alarm is displayed on any or all appropriately armed monitors.

Monitors and their respectively armed cameras are programmed individually.

Multiple alarms on monitors are sequenced automatically.

Alarmed video remains on monitors for duration of alarm input signal.

Auto-Build Mode

In the Auto-Build alarm response mode, alarms “build-up” on armed monitors as new alarms are received.

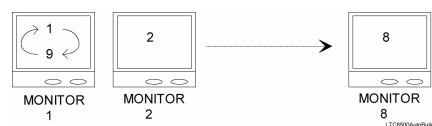

Alarm Status	Alarm Station Display
1 st Alarm	Video associated with 1 st alarm is displayed on monitor # 1 (if armed).
2 nd Alarm	Video associated with 2 nd alarm is displayed on monitor # 2 (if armed).
3 rd Alarm	Video associated with 3 rd alarm is displayed on monitor # 3 (if armed).
.	
.	
.	
8 th Alarm	Video associated with 8 th alarm is displayed on monitor # 8 (if armed).
9 th Alarm	Video associated with 9 th alarm is sequenced with video of 1st alarm on monitor # 1.

Any number of monitors may be armed.

Multiple alarms on monitors are sequenced automatically. Alarm video remains on monitors for duration of alarm input signal.

Sequence & Display Mode

In the Sequence & Display mode alarm response mode, a monitor pair is used to display alarmed video.

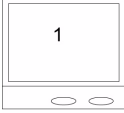
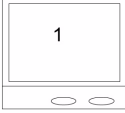
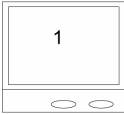
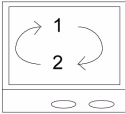
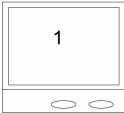
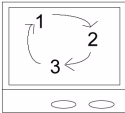
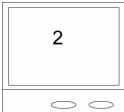
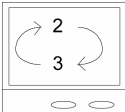
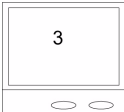
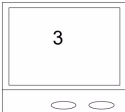
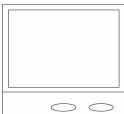
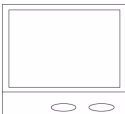
	Display Monitor	Sequence Monitor	Monitor Actions	Keyboard Operator Action
1st Alarm Occurs			D = Video associated with 1st alarm is displayed. S = Video associated with 1st alarm is displayed.	NONE
2nd Alarm Occurs			D = Video associated with 1st alarm is displayed. S = Video associated with 1st and 2nd alarm is displayed.	NONE
3rd Alarm Occurs			D = Video associated with 1st alarm is displayed. S = Video associated with 1st, 2nd and 3rd alarm is displayed.	NONE
			D = 1st alarm video is removed. 2nd alarm video is now displayed. S = Video associated with 2nd and 3rd alarms continue to sequence.	1st Alarm Acknowledged
			D = 2nd alarm video is removed. 3rd alarm video is now displayed. S = Only video associated with 2nd alarm remains.	2nd Alarm Acknowledged
		 monitors.eps	Since all alarms have been acknowledged, both monitors return to normal operator control.	3rd Alarm Acknowledged

16.7 Alarm Relay Response

Allegiant alarm responses include the ability to trigger isolated alarm relay outputs from an LTC 8540/00 Alarm Interface unit. An alarm output is typically used to activate the alarm input of a security Digital Video Recorder (DVR) or other alerting device. In this type of scenario, a DVR is programmed to change recording speeds from a slower rate to a faster rate upon alarm activation. Operation of the relay outputs from the LTC 8540 Alarm Interface unit depends on the system configuration for responding to alarm events. The alarm output relays behave according to the following conditions:

1. Relay 1 activates if the system uses the Basic alarm response mode and an alarm occurs on any system monitor. Relay 1 deactivates after all alarms have been removed from the inputs. Relay 1 also deactivates if the system (monitor or alarms) is disarmed by an operator via the keyboard. Pressing [Acknowledge] on the system keyboard does not deactivate Relay 1 since the alarm video follows the contact applied to the unit in this alarm response mode. Other relays are not used in this mode.
2. Relay 1 activates if the base system is set to use the Sequence & Display alarm response mode and an alarm occurs on any system monitor. Relay 1 deactivates after all alarm videos have been acknowledged (by pressing the [Acknowledge] key) via system operator(s) from all system monitors. Relay 1 also deactivates if the system is disarmed (either the monitor or the alarm(s)) by an operator via the keyboard. Removal of the alarm input does not deactivate Relay 1 since the alarm video(s) are not dependent on duration of the contact applied to the unit in this alarm response mode. Other relays are not used in this mode.
3. If the base system uses the Autobuild alarm response mode and an alarm occurs on system monitors, the relay corresponding to the monitor number activates for the duration that the corresponding alarm input is applied to the unit. The relay deactivates if the monitor associated with the relay or if the alarm(s) being displayed on the monitor is disarmed by an operator via the keyboard. Pressing [Acknowledge] on the system keyboard does not deactivate the relays since the alarm video follows the contact applied to the unit in this alarm response mode.
4. If the Alarm Group table screen, in the PC-based LTC 8059/00 MCS package or the LTC 8850/00 GUI Software, contains an alarm group that includes monitors and the monitor option has been selected in the Relay Action column, the corresponding relay activates for the duration the alarm video remains on the monitor. The relay deactivates if the associated monitor (or the alarm(s) being displayed on the monitor) is disarmed by an operator via the keyboard. Pressing [Acknowledge] on the system keyboard does not deactivate the relay unless this feature has been selected for the associated alarm group. If the Monitor option has been set to 1 in the group table, only Relay 1 activates when monitors in that alarm group become alarmed.

17 Keyboard Operation

17.1 General

Primary operation of an Allegiant switcher is controlled via the system keyboard. The two types of keyboards currently available are:

- Conventional LTC 8555 Series (incorporates LEDs and pushbuttons).
- IntuiKey model (uses dynamic LCD menu screens).

General operation steps for both keyboard models follows. Refer to the individual instruction manuals supplied with the keyboard for additional information.

As the system is supplied from the factory, various user selectable features are set to a default state. See Chapter 14, “Factory Default Settings,” on page 50 for complete feature descriptions. Since these features are user selectable and can have a significant effect on the operation of the system, it is important to take note of any changes that may be in effect.

17.2 System Commands

17.2.1 Keyboard Log-in Procedure

Keyboard modes:

- Factory default, a keyboard is ready for use as soon as power is applied to the system.
- System operator must log-on to a keyboard to access the system. When a system is configured to use the keyboard log-on, operators must be pre-assigned a user number and password. Up to 32 user numbers are available, each having default priority level. User specific priority levels can be changed only via the optional PC-based LTC 8059/00 MCS package or the LTC 8850/00 GUI Software. Refer to the software manual for complete details.

If the log-on feature is enabled and an operator is not logged-in, LED keyboards show flashing dashes in their display. IntuiKey keyboards prompt for entry of a user number when attempting to enter the main Allegiant softscreen menu.

Enter your assigned user number via the numeric keypad and press [Enter]. When prompted, enter the password. Invalid passwords cause the keyboard to revert to its initial state. Once the log-in is successful, the keyboard will show camera and monitor numbers in its display.

Upon logging in, the monitor controlled by the keyboard may automatically switch to a pre-assigned camera number. This function is only applicable if enabled by the system administrator (via the optional MCS package) and may not function if the monitor is running a sequence and/or in an alarm condition.

NOTE The information below applies to both IntuiKey keyboards and the LTC 8555 Series keyboards. Where applicable, button designations specific to IntuiKey keyboards are shown in plain text. Equivalent button designations that apply to the LTC 8555 Series keyboards are placed in brackets ([]) immediately after the IntuiKey button text.

17.2.2 Keyboard Log-off Procedure

If the log-in feature has not been enabled, this action is not applicable. If the feature has been enabled, press: User Log-off [User, then OFF].

Any priority based remote control or monitor locks made by the user will automatically be released at time of log-off.

17.3 Switcher Commands

- Camera Selection: Enter a camera number for viewing and press [Enter]. (The keyboard default mode is the camera mode).
- If the Allegiant is configured to operate in “6-digit Camera ID” mode, up to 6 digits can be entered. If the new camera is at the same “site” as the current camera, simply enter 1 to 4 camera number digits.

If the desired camera is at a different “site”, 5 or 6 digits must be entered. The first and second digits would be the site number and the remaining 4 digits, including any leading zeros would be the camera number at that site.
- Monitor Selection: Press MON [Monitor], enter a monitor number and press [Enter].

17.4 Controlling Camera Movement

Camera positioning is controlled via an eight-way joystick on the right-hand side of the keyboard. This joystick controls the camera pan/tilt (if equipped), moves the camera up, down, left, right, or diagonally. Moving the joystick up and to the right simultaneously moves the camera in a diagonal direction.

Rotate the joystick knob to control the zoom lens in or out. The direction of its response depends on the camera/lens model and certain system configuration settings that are determined at installation. Up to four pan/tilt/zoom commands may be sent to a remote camera site at a time (Example - Zoom In, Focus Far, Pan Left, and Tilt Down). All three (3) zoom lens functions can also be sent simultaneously (Example - Zoom Out, Focus Near, Iris Open).

17.4.1 Focus and Iris Lens Control

The lens control buttons are on the right side of the keyboard. The camera's zoom lens (if equipped) is controlled to focus near or far, and open or close the iris (if the lens supports manual iris operation).

17.4.2 Lock or Unlock Control of a Camera

When using IntuiKey keyboards, press [Device Lockout], located on the main Allegiant menu screen to enter a menu screen for these options. With the LTC 8555 Series keyboards, press [Lock], then [ON] to lock a camera. To unlock a camera, press [OFF]. If the camera to be locked is not the one currently being viewed, enter the camera number via the numeric keyboard (but do not press [Enter]) before pressing [Lock].

If the Status option is enabled, the section of the onscreen overlay between the camera number and the time shows RL, indicating the camera is locked. Activating a camera lock immediately prevents other operators (unless they have a higher priority) from controlling the locked pan/tilt/zoom camera. Remember to unlock the camera when finished so other operators can access it.

17.4.3 Lock or Unlock Control of a Monitor

- When using IntuiKey keyboards, press [Device Lockout], located on the main Allegiant menu screen for these options.
- With LTC 8555 Series keyboards, press [Monitor], [Lock], then [ON] to lock a monitor or [OFF] to unlock the monitor. If the monitor to be unlocked is not the one currently being controlled by the keyboard, enter the monitor number (but do not press [Enter]) after you press [Monitor].

If the Status option is enabled, the section of the on-screen overlay between the camera number and the time shows M_L indicating the monitor is locked. This status prevents other operators from changing the video on the monitor being used (unless they have a higher priority). Remember to unlock the monitor when finished so other operators can access it. If an operator with a higher priority accesses a locked monitor and switches to a different camera, the lock is automatically removed.

17.4.4 Recording a Camera Pre-position Scene

Select a camera with pan/tilt/zoom control and with preposition options. Using the joystick and lens controls, adjust the camera to view the scene you wish to store. When using IntuiKey keyboards, press [Camera Control], located on the main Allegiant menu screen to enter a menu screen with this option. Press Set Shot [Set], then select the scene number via the numeric keypad, and press [Enter]. The camera position is stored for recall later.

If an AutoDome Series camera is being used, certain pre-position commands are also used to activate operational features/functions. Refer to the AutoDome operation manual for complete information.

If an Allegiant conventional receiver/driver is being controlled, the pan/tilt and zoom lens must have the necessary options for pre-position operation. On certain models of AutoDomes and Allegiant Receiver/Driver Series, it is possible to disable a previously stored pre-position, or remove it from a pre-position tour, by pressing Set Shot [Set], the digit 9, followed by the 2-digit pre-position number. Refer to information supplied with the device to determine if it supports this feature.

NOTE Alarm activations are defaulted to call preposition scene 16.

17.4.5 Recalling a Camera Pre-position Scene

Select the camera to be activated. Press [Shot], enter a previously stored camera position number via the numeric keypad, then press [Enter]. The camera automatically returns to the previously stored position. If a second pre-position is called prior to the completion of the first, the camera will move directly to the second shot.

If the AutoDome Series camera is being used, certain pre-position commands are also used to activate operational features/functions. Refer to the AutoDome operation manual for complete information.

17.4.6 Activate/Deactivate Auxiliary Function

When using IntuiKey keyboards, press [Camera Control], on the main Allegiant menu screen to enter a menu containing these options. To turn on an auxiliary function of a remote camera device, press Aux ON [ON], enter the number of the auxiliary you would like to activate and then press [Enter]. Holding the [Enter] key down causes the auxiliary function to be sent repeatedly. This capability is useful when the auxiliary is activating a housing window washer function, or a temporary light source.

To turn OFF an auxiliary function of a remote camera device, press Aux OFF [OFF], enter the number of the auxiliary you would like to deactivate and then press [Enter].

With the AutoDome Series of cameras, auxiliary commands are used to activate/deactivate certain operational features/functions. Refer to the AutoDome camera manual for complete information on features supported by the model.

In the Allegiant Receiver/Driver Series, the first four auxiliaries correspond to relay outputs. Option switches in the receiver/driver can configure these to operate as either latching or momentary type functions. If configured for the latching type, the auxiliary stays on once it is activated until it is turned OFF. If configured as momentary, the auxiliary remains on only as long as the [Enter] key is pressed. Auxiliary outputs 2 through 4 can also be configured as a contact closure, 24 VAC, or as line voltage. Auxiliary number 5 controls the DITHER function, detailed below. Auxiliary number 6 corresponds to an internal receiver/driver AUTOPANNING feature, previously enabled by an option switch inside the receiver/driver.

DITHER is a legacy Allegiant receiver/driver feature designed to extend the life of tube-based low-light level cameras. Its function was to prevent bright lights in the scene from burning a spot on the camera imager. When this feature is active and the pan/tilt is not moved for a period of about two minutes, the receiver/driver automatically pans right for approximately 0.5 seconds. Two minutes later, a pan left occurs, and the cycle continues until disabled. The feature is enabled by an option switch in the receiver/driver, and is controlled by the auxiliary 5 function. To activate the DITHER function, turn [ON] auxiliary 5. To deactivate the feature, turn OFF auxiliary 5. When first enabled, the pan/tilt unit makes one short left/right cycle to indicate that the DITHER function has been activated. Note that a camera in the DITHER mode will accumulate a viewing error if left unattended for a long period of time, so occasionally a manual adjustment of the pan/tilt may be required.

17.5 Alarm Commands

17.5.1 Arm/Disarm Individual Alarms

Alarm commands control the system's automatic video switching capabilities, in response to alarm signals.

When using IntuiKey keyboards, press [Alarm Control], located on the main Allegiant menu screen, to enter a menu screen with these options. To arm an individual alarm on the monitor currently controlled by the IntuiKey, press [Arm Alarm], enter the alarm number to be armed via the numeric keypad, then press [Enter]. To disarm an individual alarm when using the IntuiKey, press [Disarm Alarm], enter the alarm number to be disarmed via the numeric keypad, then press [Enter].

To arm/disarm an individual alarm when using an LTC 8555 Series keyboard, press Alarm, enter in the alarm number to be armed via the numeric keypad, and then press [ON] to arm the alarm, or [OFF] to disarm it. The camera number activated by an alarm, by default, is the same as the alarm number, although this relationship can be changed via the optional Allegiant PC-based MCS package. When the alarm number does not match the camera number, it is important to specify the alarm number when using this command. The monitor status display (if enabled) shows CA (camera/alarm armed) whenever an armed camera is selected.

17.5.2 Arm/Disarm All Alarms

Press [Alarm Control], located on the main Allegiant menu screen to enter the menu screen containing these options. When using the IntuiKey keyboard:

- To arm all alarms currently controlled on the monitor, press [Arm All Alarms].
- To disarm all alarms, press [Disarm All Alarms].

When using the LTC 8555 Series keyboard:

- To arm all alarms, press [User]. Then, press [Alarm] and then press [ON].
- To disarm all alarms, press [OFF].

17.5.3 Arm/Disarm Monitor

When using the IntuiKey keyboard:

- Press [Alarm Control], located on the main Allegiant menu screen to enter the screen with these options.
- To arm the monitor currently controlled, press [Arm Monitor].
- To disarm the monitor, press [Disarm Monitor].

When using the LTC 8555 Series keyboard:

- To arm the monitor, press [User]. Then, press [Monitor] and then press [ON] to arm all alarms.
- To disarm all alarms, press [OFF].

NOTE Alarm video appears on a monitor only if the monitor is armed and the alarm is armed for that monitor. The monitor status display (if enabled) will show M_A (monitor armed).

17.5.4 Alarms Acknowledgement

Bell [Ack] is provided so system operators can respond to alarms from the keyboard. Press Bell [Ack] when the keyboard is beeping (due to an alarm condition) to silence the beeper. Depending on alarm configuration programming, subsequent pressing of Bell [Ack] either clears an alarm video from the monitors or has no effect.

17.6 Sequence Control

17.6.1 Load/Clear a Sequence

To load a previously programmed sequence to run on your monitor, press Load Sequence [Seq], enter the desired sequence number (1 to 60), then press [Enter]. Note that loading a sequence does not automatically start the sequence running. Since sequences may be programmed to use more than one monitor, all required monitors must be available. If a sequence is already on a monitor, the operator who loaded it originally (or an operator with a higher priority) is permitted to load a new sequence on the monitor(s). Others will receive an error message.

To clear a monitor sequence, press Load sequence [Seq], then press [Enter]. Only the operator who originally loaded it (or an operator with a higher priority) is permitted to clear a monitor sequence. Others will receive an error message. If enabled, the status display area of the monitor indicates the sequence number in the appropriate location. If no sequence is currently loaded, 00 is displayed.

17.6.2 Run a Sequence

To run a sequence currently loaded on a monitor, press Start Sequence [Run]. If the sequence is stopped, the command starts sequencing. Direction of the sequencing is indicated in the monitor status display (if enabled), by a directional arrow and the letter R to the right of the sequence number. If Start Sequence [Run] is pressed while a sequence is already running, the switcher goes immediately to the next step in the sequence. Holding down Start Sequence [Run] produces a quick-scan effect. If Start Sequence [Run] is depressed when no sequence is loaded, an error results. If the monitor is in alarm, Start Sequence [Run] controls switching of alarm video rather than a loaded sequence.

17.6.3 Stop a Running Sequence

To stop a sequence that is currently running, press Hold Sequence [Hold]. The monitor status display shows a S to the right of the sequence number. If the sequence is already stopped, pressing Hold Sequence [Hold] has no effect. If no sequence is currently loaded, pressing Hold Sequence [Hold] results in an error condition. If the monitor is in alarm, Hold Sequence [Hold] stops the alarm switcher rather than a loaded sequence.

17.6.4 Controlling Sequence Direction

The direction of a sequence can be set to run either forward or reverse. It is also possible to manually step forward or reverse through a stopped sequence.

These actions work as follows:

If Next Sequence Step [Next] is pressed with the sequence in the stop state, the sequence switches forward and remains stopped. If the sequence is running when Next Sequence Step [Next] is pressed, it immediately goes to the next step and continues to run. The same is true for the Previous Sequence Step [Prev] button, but in the reverse direction. If either Next Sequence Step [Next] or Previous Sequence Step [Prev] is held down, quick-scan switching at a rate of approximately two steps per second will take place. When sequences are first loaded, their direction defaults to forward.

If Previous Sequence Step [Prev] is pressed while a camera sequence is running, it reverses the sequence. If Previous Sequence Step [Prev] is pushed while in a hold mode, and the display is showing the forward prompt, the first push changes the direction only, and a second push then switches to the previous step.

The same is true for Next Sequence Step [Next] in the opposite direction. The monitor status display shows an arrow pointing either up or down to indicate the sequence direction. The arrow will be to the right of the sequence number, either above or below the sequence run R or stopped S indicator. If the monitor is in alarm, Previous Sequence Step [Prev] and Next Sequence Step [Next] control the alarm switcher rather than the loaded sequence.

If no sequence is loaded, pressing Next Sequence Step [Next] or Previous Sequence Step [Prev] automatically steps the switcher through the camera numbers in numerical order.

17.7 Sequence Programming

17.7.1 Programming a Simple Camera Sequence

The Allegiant system has powerful sequencing capabilities. Using a system keyboard, it is possible to enter sequences to run on a single or on multiple monitors. As long as valid camera and monitor numbers are used, they can be entered into a sequence randomly. More powerful features are available when sequences are programmed via the PC-based LTC 8059 MCS, including receiver/driver activation as part of a sequence step.

Sequence programming is limited only by the amount of CPU memory reserved for storing the sequence steps.

The current limit for these Allegiant models is 3000 steps. Comparing a sequence to a spreadsheet, a simple sequence would consist of three (3) columns as follows:

CAMERA	MONITOR	DWELL
1	1	2
2	1	2
3	1	2
4	1	2
5	1	2

Sequence programming is best described by going through the above example. To enter the programming mode, press Program Sequence [Prog]. Enter an available sequence number (1 to 60 for these Allegiant models), then press [Enter]. The on-screen monitor display changes to the following format:

1st Line = Site ** S0001 L0001 Time(Ignore)

2nd Line = >C0001< M001 D02 Date(Ignore)

** 2-digit site number will be displayed only if 6-digit camera ID is mode is enabled.

The top line of the display always indicates the current step being viewed in the S0001 section. The total length of the sequence is displayed in the L0001 section. When programming a new sequence, the camera number that was being viewed before entering the programming mode is automatically placed between the > < prompts, as in the example C0001 above. Now enter the 1st camera of the sequence into this position. If 6-digit camera ID mode is enabled, five or six digits must be entered. If the camera number is correct, no action is necessary. If not, enter the desired camera number via the keypad and press [Enter].

Using the joystick, move RIGHT one step. The prompts will shift over to the monitor number shown in the example M001. The monitor that was being controlled by the keyboard before entering the programming mode is defaulted to this position. If correct, no action is necessary. If not, enter the desired monitor number via the keypad, and press [Enter].

Move RIGHT again. The prompts now shift over to the dwell time shown in the example D02. The default dwell time for a new sequence is always two (2) seconds. If a different dwell period is desired, change the value to any number between 1 and 60. One line is now complete. Press Next Step [Next] to add a second line. The camera number increments automatically, while the monitor number and dwell remain the same as the first line. Since this line is correct, no change is necessary and Next Step [Next] may be pressed three (3) more times until line five (5) is reached. The joystick can be used to move around within the spreadsheet, but only the Next Step [Next] key can add new lines.

Continue entering camera, monitor, and dwell times in this fashion until finished. If you only want to store the sequence for future use and then exit the programming

mode, press Exit/Save [Prog]. Press Exit/Run [Run], to exit the programming mode, store the sequence into memory, and start the sequence running. The switcher steps through the five (5) steps in the order shown, and repeats the sequence when it reaches the last step.

To program a sequence to run once through all its steps and then stop, enter the value 62 for the dwell time in the last step and press [Enter]. The dwell display will change to STP, meaning stop. To program a sequence to run once through all its steps and then unload itself, enter the value 63 for the dwell time in the last step, and press [Enter]. The dwell display will change to ULD, meaning unload.

To edit an existing sequence, press Program Sequence [Prog], enter the existing sequence number, then press [Enter]. You can insert a line into a sequence by navigating down to the line where inserting a new line, and press Insert Step [ON]. A new line identical to the one you are on is added to the next step. To delete a step, navigate to the line to be deleted, and press Delete Current Step [OFF]. To delete all steps below the line you are viewing, press Delete From Here To End [Lock]. (Be careful with this feature!)

It is also possible to erase a sequence: Press Delete From Here To End [Lock] while on the first line of the sequence. Then press Delete Current Step [OFF]. The sequence will be erased, and the programming mode is automatically exited.

Sequence Function Summary

All programming key functions for the LTC 8555 Series are summarized in the following table:

Key	Description
PROG	Selects or terminates program mode
CLEAR	Clears current entry
ENTER	Stores current entry
PREV	Stores entry and move up one step
NEXT	Stores entry and move down one step; add new step if necessary
ON	Insert step before current step
OFF	Delete current step
UP	Move up one step
DOWN	Move down one step, if step already exists
LEFT	Move prompt left one cell
RIGHT	Move prompt right one cell
LOCK	Erase all steps after current step
RUN	Exit, store, load, and run current sequence

17.7.2 Programming a SalvoSwitching Camera Sequence

A SalvoSwitching sequence can be used to switch a group of monitors simultaneously as a synchronized group. To program a Salvo sequence, enter the programming mode as described above for a simple camera sequence. By definition, Salvo sequencing involves more than one monitor. An example of a simple Salvo sequence that switches cameras on three (3) monitors simultaneously is shown below:

CAMERA	MONITOR	DWELL
1	1	SLV
2	2	SLV
3	3	2
7	1	SLV
8	2	SLV
9	3	2
21	1	SLV
22	3	SLV
23	3	2

In general, follow the instructions used for the simple camera sequence (described above), but instead of entering a number of seconds for steps that must switch instantly, enter 61 and press [Enter]. This causes the switcher to automatically change to the salvo abbreviation SLV. Dwell time (in seconds) is entered only when you reach the step containing the last monitor that will be switched within the synchronized group.

18 Keyboard User Functions

18.1 General Information

User functions are keyboard operations which are used infrequently, but provide important system options.

NOTE: Certain functions are restricted to certain user priority levels. Additional information on user priority levels can be found in the See Chapter 15, “User Information,” on page 56. To execute these user functions, select the desired function, and follow the general steps below.

For IntuiKey keyboards, User Functions are accessed using the following procedure:

1. From the main Allegiant screen, press [User Functions] (softkey).
2. Use Previous or Next to navigate to the desired function or press the [Enter User Command] key and enter the desired number.
3. Press the desired softkey.

For LTC 8555 Series keyboards, User Functions are accessed using the following procedure:

1. Press [User] and verify the indicator lights.
2. Using the numeric keypad, enter the desired User Function number.
3. Press [Enter]. Note that the keyboard camera display shows F followed by the selected function number.
4. Follow the directions for the specific user function (described in its section, herein). In many cases, the joystick is used to select options
5. Press [User] to exit back to normal mode.
USER 2 ENTER

The above example accesses User Function #2 as described below.

These functions are listed in the table shown below.

Fn#	Joystick Up/Down	Joystick Left/Right	Function Description	Pass- word Re.	Access Level		
					1	2-7	8
1	n/a	n/a	Local keyboard test	Y	Y	Y	
2	n/a	n/a	Show keyboard port number	Y	Y	Y	
3	n/a	n/a	Select keyboard beeper ON/OFF	Y	Y	Y	
4	Up/Down	Left/Right	Adjust position of monitor display	Y	Y	N	
5	Brightness	Msg vs. Stat	Monitor display brightness/status selection	Y	Y	N	
6	Time/Date ON/OFF	Overlay ON/OFF	Select monitor display option	Y	Y	N	
7	Set	Select	Set time	Y	Y	N	
8	Set	Select	Set date	Y	Y	N	
9	Set	Select	Set camera ID	Y	N	N	
10	n/a	n/a	Change user password	Y	Y	Y	
11	Select	n/a	Select time/date format	Y	N	N	
12	n/a	n/a	Default all monitor overlays	Y	N	N	
13	Select	n/a	Print configuration tables to system printer	Y	N	N	
14	n/a	n/a	Reserved	-	-	-	
15	n/a	n/a	Reset system	Y	Y	N	
16	Select	Enable/Disable	Time event enable/disable	Y	N	N	
17	Set	Select	Set monitor ID	Y	N	N	
18	Select	n/a	Print sequence	Y	N	N	
19	Select	n/a	Select alarm response	Y	Y	N	
20	Select	n/a	Select printer verbosity	Y	N	N	
21	Select	n/a	Designate alarm monitor type	Y	Y	N	
22	Select	n/a	Select control code format (fixed/variable)	Y	N	N	
23	n/a	n/a	Display CPU software version number	Y	Y	Y	
24	Up/Down	Left/Right	Set positions on all monitor displays	Y	Y	N	
25	Brightness	Msg. vs. Stat.	Brightness/Status select on all monitor displays	Y	Y	N	
26	Time/Date	Overlay	Set display option on all monitors	Y	Y	N	
27	Keyboard Log-in	Select	Select keyboard log-in	Y	Y	N	
28	Console Log-in	Select	Select console log-in	Y	Y	N	
29	Default Parameters	Select	Default RS-232 parameters	Y	Y	N	
30	Console Parameters	Select	Set console RS-232 parameters	Y	Y	N	
31	Printer Parameters	Select	Set printer RS-232 parameters	Y	Y	N	
32	Alarm Parameters	Select	Set Alarm RS-232 parameters	Y	Y	Y	
33	n/a	n/a	Display user number and priority	Y	Y	Y	
34	Select	n/a	Camera indicator	Y	N	N	
35	Camera No.	Enable/Disable	Controllable cameras	Y	N	N	
36	Select	Enable/Disable	Select crosspoint data	Y	N	N	
37	Select	n/a	R/D addresses mode	Y	N	N	
38	Select	n/a	Printer port mode	Y	Y	N	
39	Select	n/a	Select DIU interface port	Y	Y	N	
40	n/a	n/a	Reserved	-	-	-	
41	Select	n/a	Set Satellite Communication Format	Y	Y	N	
42	Select	n/a	Keyboard log-in auto-off mode	Y	Y	N	
43	n/a	n/a	CPU battery status	Y	Y	Y	
44	Select	n/a	Camera vertical phase set	Y	Y	N	
45	n/a	n/a	CPU temperature status	Y	N	N	
46	Select	n/a	Two/Three Line Titles	Y	Y	N	
47	Select	n/a	Six-Digit Camera ID	Y	Y	N	
99	Select	n/a	Use functions index	Y	Y	Y	

User Function 1 - Local Keyboard Test

User Function 1 can be used as a local test to ensure that all the keyboard LEDs and switches are working. This function automatically calibrates the center position of the analog joystick on LTC 8555 keyboards. Upon entering this test, the keyboard will beep and all LEDs will light for about two (2) seconds. The USER should note if there are any LED failures.

Each key may be pressed to display a unique code number associated with that key. Follow the table below to ensure that all keys are properly being processed by the keyboard. Push [USER] last, as this causes the keyboard to exit the test mode. If the log-on system feature has been selected by the system installer, the same local test may be initiated while the keyboard is not ON LINE by pressing * (STAR).

Key	No.
IRIS UP	044
IRIS DOWN	045
FOCUS UP	042
FOCUS DOWN	043
ZOOM CLOCKWISE ¹	041
ZOOM COUNTERCLOCKWISE ¹	040
ALARM	004
USER	000
SEQUENCE	032
HOLD	036
RUN	033
PREVIOUS	035
NEXT	034
#1	010
#2	018
#3	026
#4	011
#5	019
#6	027
CAMERA	024
MONITOR	008
ACKNOWLEDGE	005
PROGRAM	002
SET	001
SHOT	009
OFF	025
ON	017
* (STAR)	016
LOCK	003
#7	012
#8	020
#9	028
CLEAR	037
#0	013
ENTER	029
UP ¹	052
RIGHT ¹	051
DOWN ¹	050
LEFT ¹	053

¹ Keyboard tests show a speed indicator value in the first digit position when performing pan, tilt, or zoom actions.

User Function 2 - Show Keyboard Port Number

User Function 2 may be used to identify which port a keyboard is plugged into. After entering User Function 2, read the keyboard port number from the monitor display on the keyboard. If using the LTC 8555 Series keyboard, press [User] to exit.

User Function 3 - Select Keyboard Beeper ON/OFF

When User Function 3 is selected, the keyboard user may enable/disable the keyboard audio beeper. If using the LTC 8555 Series keyboard, press [ON] to enable the beeper or [OFF] to disable it. Press [User] to exit. Upon power up of the keyboard and whenever the Allegiant system undergoes a reset, this setting is set to [ON].

User Function 4 - Adjust Position of Monitor Overlay

User Function 4 allows the characters on the video monitor display to be positioned from the keyboard. Only the display on the monitor that the keyboard is currently connected to is affected. If using the LTC 8555 Series keyboard, use the joystick to position the display as required. Press [Enter] to store the position. Press [User] to exit.

User Function 5 - Monitor Display Brightness/Status Selection

The white portion of the characters on the video monitor display may be made brighter or dimmer by the User Function 5. Only the display on the monitor that the keyboard is currently connected to is affected. After entering the mode, there are four possible settings. If using the LTC 8555 Series keyboard, moving the joystick up increases the brightness, and moving it down decreases the brightness.

The User Function 5 also permits selection of either the status display or a 12-character monitor message to appear in the first line of the monitor display. The status display indicates alarm, sequence, and lockout information regarding the monitor. The monitor message is a stationary display. This means the display will not change as video is switched from camera to camera on the monitor. After entering the mode, move the joystick left to select monitor message format, and right to select status format. If using LTC 8555 Series keyboard, to exit the mode, press [User].

User Function 6 - Select Monitor Display Option

User Function 6 allows the user to remove the time and date (the left side of the display), or the entire display from the individual monitor. If using the LTC 8555 Series keyboard, move the joystick down to blank the time and date from the screen. This is sometimes desirable when a signal from a DVR with its own time and date is being used. Move the joystick up to add the time and date back. Move the joystick left to blank the left side portion of the display from the monitor, and right to return it. Refer to User Function 5 to verify brightness level. Press [User] to exit the mode.

User Function 7 - Set Time

User Function 7 enables user setting of the time displayed on all system monitors. After entering the mode, use the joystick to select hours, minutes, or seconds in an edit line (displayed on the monitor screen). If using the LTC 8555 Series keyboard, moving the joystick up or down counts the data item up or down; moving right or left selects between data items. NEXT is used to set the seconds to zero. If [NEXT] is pressed when the seconds are over 30, the minute count (shown on the operating clock display) is incremented. If [NEXT] is pressed when the seconds are under 30, the minutes are left unaffected. Press [Enter] to update the time displayed on all system monitors, and press [User] to exit the mode.

User Function 8 - Set Date

User Function 8 enables the user to set the date displayed on all system monitors. If using the LTC 8555 Series keyboard, use the joystick to select the day, month, or year in an edit line (displayed on the monitor screen). Move the joystick up or down to count the data item up or down; move right or left selects between the data items. If using the LTC 8555 Series keyboard, press [Enter] to update the date displayed on all system monitors. Press [User] to exit the mode.

User Function 9 - Set Camera ID

User Function 9 permits entry of a 16-character camera identification message. This message appears on the video monitor display whenever the specific camera is called up for viewing. If desired, this message can be used to identify the particular scene being viewed. See Chapter 20, "Character ROM Tables for LTC 8600 and LTC 8800," on page 86 for the various characters available. After entering the mode, users with priority level 1 can use the joystick to move right or left to select the character to be changed. The selected character will be identified by a box with a question mark inside it. The first line of the video monitor screen indicates the code number of the character selected. Move the joystick up or down to step through the Character ROM Table, or enter the character's number (as identified in the tables) via the numeric keypad, and press [Enter]. Once the title has been set, press [Enter] to store it to memory. If using the LTC 8555 Series keyboard, press [User] to exit the mode.

User Function 10 - Change USER Password

User Function 10 is used to change an operator's keyboard log-on access password. This feature is only required in systems where the system installer has enabled the keyboard log-in security feature. After entering the mode, the video monitor display prompts for the current password OLD PASSWORD. Enter the current user password via the numeric keypad, and press [Enter]. If the system does not accept the old password, the system remains at this prompt. If the entered password is valid, the display changes to the NEW PASSWORD prompt for entry of the new password (up to six (6) numerals) via the numeric keypad, then press [Enter]. Leave this step blank if no password is desired. If none is used, at log-on, press [Enter] at the P prompt. To safeguard against typographical errors, the system prompts VERIFY PASSWORD requiring reentry of the new password. If the entered passwords do not agree, the system prompts for reentry and verification of the new password. If the two password entries agree, the video monitor prompt indicates PASSWORD UPDATED.

Press [User] to exit the mode.

User Function 11 - Select Time/Date Format

User Function 11 is used to set the time and date format used throughout the system. The two (2) formats of time available are - 12-hour mode and 24-hour mode. The date is available in a MM-DD-YY format (U.S.), a DD-MM-YY format (International), and a YY-MM-DD format (Asian). After entering the mode, move the joystick up or down to select the desired format. If using the LTC 8555 Series keyboard, press [Enter] to convert the system to the format chosen, then press [User] to exit the mode.

User Function 12 - Default All Monitor Overlays

User Function 12 is used to reset all monitor overlays to default characteristics; bottom center of screen, and full brightness. After entering the mode, press [Enter] to reset all monitor overlays. If using the LTC 8555 Series keyboard, press [User] to exit.

User Function 13 - Print System Configuration Tables

Use this function to print the contents of the various system configuration tables. Move the joystick up and down to select a table, then press [Enter] to send it to the printer port. If using the LTC 8555 Series keyboard, press [User] to exit.

User Function 14 - Reserved Function

User Function 15 - System Reset

The system may be reset from the keyboard. After entering this mode, the video monitor screen indicates RESET SYSTEM. Enter the password via the numeric keypad, and press [Enter]. The system will then reset. If using the LTC 8555 Series keyboard, press [User] to exit the mode without resetting the system.

NOTE: The system should be reset whenever a change is made on the main CPU module's DIP switches. Alternatively, the main power to the CPU bay may be switched off for ten (10) seconds, then restored. Depending on the size and complexity of the system, several seconds may be required before operation is restored. This time is due to the amount of initialization tasks being performed, and is considered normal.

User Function 16 - Time Event Enable/Disable

Use this function to enable or disable any of the programmed time event functions. Up to 64 time event functions can be programmed with the optional LTC 8059/00 MCS, or the LTC 8850/00 GUI Software. Moving the joystick up and down steps through a table of the 64 time events. If an event has been programmed, moving the joystick to the right enables the event, and to the left disables it. The current status of an enabled time event is displayed by this user function.

User Function 17 - Set Monitor ID

User Function 17 is used to enter a (12-character) monitor identification message for display in the top line of the monitor overlay display on any system monitor(s). This monitor title will be visible on the display regardless of the camera currently being viewed. This message can be used to identify the particular monitor or a group of cameras assigned to this monitor. See Chapter 20, "Character ROM Tables for LTC 8600 and LTC 8800," on page 86 for the available characters.

After entering the mode, the joystick is moved right or left to select the character to be changed. The selected character is identified by a box with a question mark inside it. The first line of the video monitor display indicates the code number of the character selected. Move the joystick up or down to step through the Character ROM Table, or enter the character's number identified in the Tables via the numeric keypad, then press [Enter]. Once the monitor title has been set, press [Enter] to store it to memory. If using the LTC 8555 Series keyboard, press [User] to exit the mode. The user may select between this monitor message and the status display by using the User 5 Function described above.

User Function 18 - Print Sequence

Use this function to print the contents of a programmed sequence. Use the joystick to select the desired sequence, then press [Enter] to print it to the printer port. Only those sequences currently existing in memory will be shown in the list. If using the LTC 8555 Series keyboard, press [User] to exit.

User Function 19 - Select Alarm Response

Use this function to reset the system alarm configuration tables to one of these pre-defined alarm response modes: BASIC, AUTOBUILD, or SEQUENCE & DISPLAY. Move the joystick up or down to select the desired mode, then enter your user password on the numeric keypad. Press [Enter] to update the alarm system. If using the LTC 8555 Series keyboard, press [User] to exit.

NOTE Existing alarm configuration data will be lost when mode is changed.

User Function 20 - Select Printer Verbosity

Use this function to select between print modes; Limited Printing and Full Printing. This selection determines the amount of information printed during alarm processing. Both modes print alarm activation and deactivation messages, but Full Printing goes into much more detail. Use the joystick to select the desired mode, then press [Enter]. If using the LTC 8555 Series keyboard, press [User] to exit without changing the print mode.

User Function 21 - Designate Alarm Monitor Type

Use this function to designate the monitor currently controlled by the keyboard as either a STEP monitor or a REVIEW monitor. This function can only be used in the predefined SEQUENCE & DISPLAY alarm response mode (see ALARM INFORMATION section) to select which monitor is the STEP (also called SEQUENCE) monitor, and which is the REVIEW (also called DISPLAY) monitor. To designate a monitor as the STEP or REVIEW monitor, enter User Function 21, then move the joystick up or down to select the monitor type. Enter your password on the keyboard and press [Enter]. If using the LTC 8555 Series keyboard, press [User] to exit. After selecting new STEP and REVIEW monitors, the previous ones may be disarmed (Arm/Disarm Monitor instructions).

User Function 22 - Select Control Code Format

This function designates whether variable speed pan/tilt and zoom commands are enabled (Factory Default Setting). In most cases, there is no need to disable this function. Move the joystick up or down to select the desired setting, then press [Enter]. If using the LTC 8555 Series keyboard, press [User] to exit.

User Function 23 - Display CPU Software Version Number

Use this function to display the revision number of the Allegiant's CPU software on the monitor screen.

User Function 24 - Set Positions on All Monitor Displays

This function is similar to User Function 4, except it changes the monitor display positions of all monitors in the system. After entering User Function 24, use the joystick to position the display as required on the monitor controlled by the keyboard. Press [Enter] to store and change all system monitor displays to this position. If using the LTC 8555 Series keyboard, press [User] to exit.

User Function 25 - Set Brightness on All Monitor Displays

This function is similar to User Function 5, except it changes the monitor display brightness of all monitors in the system. The white portion of the characters on the video monitor displays may be made brighter or dimmer via the User Function 25. Move the joystick up to increase brightness, or down to decrease brightness. Once the display on the monitor that the keyboard is currently controlling is adjusted, press [Enter] to change all system monitors to the same setting. Press [User] to exit the mode.

The User Function 25 mode can also select either the status display or a 12-character monitor message to appear in the first line of the monitor display. The status display indicates alarm, sequence, and lockout information regarding the monitor. The monitor message is a stationary display; the display will not change as video is switched from camera to camera on the monitor. After entering the mode, move the joystick left to select the monitor message format, or right to select the status format on the monitor the keyboard is controlling. Press [Enter] to change all system monitors to the same setting. If using the LTC 8555 Series keyboard, press [User] to exit.

User Function 26 - Set Display Option On All Monitors

This function is similar to User Function 6, except it selects the monitor display option of all monitors in the system. The User Function 26 mode allows removal of the time and date, the left side of the display, or to remove the entire display from the system monitors. Move the joystick down to blank the time and date from the screen. This is sometimes desirable when a DVR with its own time and date is being used as a video source. Move the joystick up to add the time and date back again. Move the joystick left to blank the left side of the display from the monitor and right to return it. Refer to User Function 5 or 25 to verify brightness level. Press [Enter] to update all system monitors to the selected format. If using the LTC 8555 Series keyboard, press [User] to exit.

User Function 27 - Select Keyboard Log-in

This function controls the system's keyboard log-in feature. Move the joystick up or down to select the mode for the system to function in. If the log-in feature is enabled (MUST USE KBD PWD is selected), the system keyboards require each user to log-in and log-off the system. All users are required to enter a user number and correct password to interact with the system. If the log-in feature is disabled (NO KBD PWD LOGIN is selected), system keyboards are always online with the system. Once selection is made, exit the User Function mode and reset the system either via keyboard User Function 15, or by removing and restoring the main AC power to the system. Once the system has been reset, the keyboard log-in function will be active and all system keyboards will need to be logged-in to access the system.

User Function 28 - Select Console Log-in

This function controls the system's external console port log-in feature. After entering the mode, move the joystick up or down to select the mode in which the system should function. If the log-in feature is enabled (MUST USE CON PWD is selected), any external PC or other computing device will be required to log-in to communicate with the system. External computing devices are required to enter a user number and correct password. If the console log-in feature is disabled (NO CON PWD LOGIN is selected), the console port is available for communication.

Once the selection is made, exit the User Function mode and reset the system, either via keyboard User Function 15 or by removing and restoring the main AC power to the system. Once the system has been reset, the console log-in function is active, and all external computing devices need to log-in to access the system.

User Function 29 - Reset RS-232 Parameters to Default

This function returns the system's external RS-232 ports to a known default state. After entering the mode, enter a valid password. The system will reset after placing the RS-232 protocols back to the default state. See Chapter 14, "Factory Default Settings," on page 50 for additional information.

User Function 30 - Set Console RS-232 Parameters

This function is used to set the RS-232 baud rate and handshake options for the system's console port. Upon entry to this mode, the current settings are displayed. Move the joystick up/down to select the baud rate, and left/right to select the handshake option. After being changed, the port is also automatically set to eight data bits, no parity, and one stop bit. Once new settings have been selected, enter the user password and press [Enter]. If using the LTC 8555 Series keyboard, press [User] to exit.

User Function 31 - Set Printer RS-232 Parameters

This function is used to set the RS-232 baud rate and handshake options for the system's printer port. Upon entry to the mode, the current settings are displayed. Move the joystick up/down to select the baud rate, and left/right to select the handshake option. After being changed, the port is also automatically set to eight data bits, no parity, and one stop bit. Once new settings have been selected, enter the user password and press [Enter]. If using the LTC 8555 Series keyboard, press [User] to exit.

User Function 32 - Set Alarm RS-232 Parameters

Use this function to select the RS-232 baud rate and handshake options for the system's alarm port. Upon first entering the mode, the current settings will be displayed. Moving the joystick up/down selects the baud rate. Moving the joystick left/right selects the handshake option. After being changed, the port is also automatically set to eight (8) data bits, no parity, and one stop bit. Once the new settings have been selected, enter the user password and press [Enter]. Press [User] to exit the mode.

User Function 33 - Display User Number and Priority

This function displays the current user's number and priority level on the monitor screen. The user number will be displayed on the top line and the user's priority level will be displayed on the bottom line of the monitor screen. If using the LTC 8555 Series keyboard, press [User] to exit.

User Function 34 - Camera Indicator

This function is used to enable an onscreen indicator to identify a pan/tilt equipped camera. Move the joystick up or down to select DISP CAM CONTROL or NO CAM CONTL DISPL. Press [Enter] to activate your selection. When enabled, cameras identified as controllable (via User Function 35 or the optional LTC 8059/00 MCS package), show a  in the middle of the first line of monitor text.

User Function 35 - Controllable Cameras

Priority 1 users can use this function to select camera sites equipped with pan/tilt devices. Move the joystick up or down to select the camera number, and left or right to select FIXED or MOVABLE. User Function 34 or the optional PC software package enables or disables the display of the controllable camera indicators on the system monitor displays.

User Function 36 - Select Crosspoint Data

Use this function to select options for accessory device data that can be sent out the biphase control port. Move the joystick up or down to select XPOINT DATA, ALARM XPOINT, or PHYSICAL CAMERA NUMBER, and left or right to enable/disable the selected option. These options are typically applicable only when LTC 8770 Series Switcher Follower accessory devices are being used in the system.

User Function 37 - R/D Address Mode

Priority 1 users can use this function to select whether the biphase control data commands will be addressed using the cameras' logical numbers or physical number indexes in the Camera Table. Move the joystick up or down to select LOGICAL or PHYSICAL and press [Enter] to activate your selection. If this option is set to LOGICAL, AutoDome Series cameras and Allegiant Series receiver/drivers should be addressed using the cameras' logical identification number. If it is set to PHYSICAL, the devices should be addressed using the cameras' physical port number.

User Function 38 - Printer Port Mode

This function allows configuration of the system's PRINTER port for use with a LTC 8712 Series Console Port Expander accessory device. Move the joystick up or down to select the printer port function; NORMAL or EXPANDED. Press [Enter] to activate your selection. Reset the system for this setting to take effect.

User Function 39 - Select DIU Interface Port

Use this function to select the switcher's interface port to be connected to an external LTC 8016/90 Allegiant Bilinx Data Interface accessory unit. Move the joystick up or down until the desired port for use as a data interface (DIU) is displayed. Press [Enter] to configure the port. If using the LTC 8555 keyboard, press [User] to exit the mode.

User Function 40 - Reserved Function

User Function 41 - Set Satellite Communication Format

This function provides three (3) configuration options that determine the behavior and content of the data commands issued by a master system to a satellite system. In most cases, it is only necessary to change the default setting if using a multi-level cascaded Allegiant satellite system configuration. (see Section Appendix A "Satellite Systems," on page 107 for more information on satellite system configurations.)

Detailed descriptions of these options are listed below.

After entering the mode, move the joystick up or down to select the desired option. Enter a valid user password, and press [Enter].

- **CACHE REM CAM option** (default factory setting). In this mode, satellite commands are issued repetitively, regardless of whether the satellite camera is still being viewed by an operator. This mode of operation is more desirable in standard systems because it minimizes delays when previous satellite cameras are reselected. It is not recommended for use in cascaded systems. In cascaded systems, this mode could result in all available trunk lines coming from the 3rd level satellite system to become used up, making them unavailable to the operators at the intermediate system.
- **NO REM CAM CACHE option**. In this mode, after the top level operator selects a locally connected camera, the trunk line between the top level and the intermediate level system will immediately be reset to its start-up camera (as defined in the Monitor Table of the LTC 8059/00 MCS). This in turn frees up the trunk line between the intermediate level system and the 3rd level system so it will be available if needed by an operator at the intermediate level system.

In addition, this option changes the behavior of how the system determines which trunk line to use. When this option is not used, a new trunk line (if available) will be used for each camera selection. When this option is enabled, an operator's monitor will use the same trunk from the same bay as different cameras are selected, as long as no other operator is viewing the same satellite camera. In 3-tier cascaded satellite systems, this feature minimizes the use of trunk lines by the top level Master system. This is especially advantageous when the operator at the Master site is viewing cameras from the 3rd level satellite. Since this will result in less trunk lines being used up, the intermediate Master/Satellite system will have more access to trunk lines from the 3rd level satellite.

- **SAT nnn PRIORITY option**. If the top level master system and intermediate level system in a cascade configuration can or will be set to operate as "Dual Master" systems, a priority based satellite camera selection feature can be configured. In a default cascaded satellite system configuration, satellite switching commands are not associated with a user priority level. When a switching command sent from a master site is received by a satellite, the switch selection can imme-

diately be overridden by operators at the satellite location having any priority level. This situation is more likely to be encountered in 3-tier satellite systems that do not have a good distribution of trunk lines (i.e., more between the top level system and the intermediate level system than there are between the intermediate system and the 3rd tier satellite).

Since dual master configurations support bi-directional communications, selecting the SAT nnn PRIORITY option for both the top level and intermediate level master systems will result in the generation of priority based satellite commands.

The satellite number assigned to the system that is currently being programmed must be specified for the nnn value. This feature will enable use of the operator's user priority to determine if access to a desired satellite camera is provided or not. For instance, if no trunk lines are available and an operator requesting a satellite camera has higher priority than at least 1 of the existing operators, the requested camera will be switched. If the operator does not have sufficient priority, they will receive an error message (i.e., error 81) via the satellite communication path, and their camera will switch to the start-up camera specified in the Monitor Table.

In addition, the same behavior for selecting trunk lines as described in the NO REM CAM CACHE option is applicable to this option. An operator's monitor will use the same trunk from the same bay as different cameras are selected, as long as no other operator is viewing the same satellite camera.

User Function 42 - Keyboard Log-in Auto-off Mode

Priority 1 users can use this function to select a keyboard log-off feature to automatically log a keyboard off after a pre-selected time of inactivity. After entering the mode, move the joystick up or down to select the desired time period. Enter a valid password, and press [Enter]. If using the LTC 8555 keyboard, press [User] to exit the mode.

User Function 43 - CPU Battery Status

Use this function to view the condition of the batteries used to backup CPU memory. Once the function is entered, the condition is displayed on the monitor text display. If using the LTC 8555 keyboard, press [User] to exit the mode.

User Function 44 – Camera Vertical Phase Set

NOTE: This feature requires the following:

1. LTC 8621 or LTC 8821 video input modules having firmware 5.30 or later.
2. Dinion series of cameras using Bilinx communications.
3. AutoDome series of cameras using either Bilinx or Biphase data communications.
4. LTC 8016/90 Bilinx Data Interface unit having firmware 1.01 or later.
5. All cameras configured to use Line Lock mode.

Priority 1 users can use this function to automatically adjust the phase interval delay of compatible cameras connected to the system. This will result in roll-free switching as the cameras are manually selected or automatically sequenced on system monitors.

After entering the function, the joystick down/up is used to select either an individual camera to adjust or all cameras. Enter a valid user password number and press [Enter] to activate the adjustment process.

Some minor disturbance of the video images may be visible for 1 or 2 seconds while the cameras are being adjusted. If no changes are noticed, check to make sure that you have compatible devices in your system.

If using an LTC 8555 keyboard, press [User] to exit the mode.

User Function 45 – CPU Temperature Status

Use this function to view the condition of the CPU temperature. Once the function is entered, the condition is displayed on the monitor text display.

If using the LTC 8555 keyboard, press [User] to exit the mode.

User Function 46 – Two/Three Line Titles

Use this function to enable a third line of on-screen text. This new line can be used to display up to 24 additional camera title characters, providing a total of 40 characters (or 20 'double width' characters) for each camera. Alternatively, this line can be used to display the 12-character Monitor title.

Once the function is entered, move the joystick up/down to select the desired option. Enter a valid user password, and press [Enter]. The on-screen display of some system monitors may take up to 1 minute before changing.

After enabling/disabling this feature, it is recommended to enter User Function 24 (see above) to adjust vertical height of the on-screen text to the desired position.

Note: At time of this publication, the available version of the PC-based LTC 8059 Master Control Software only supports user programming of the standard 16 characters of the camera titles. The additional 24 characters can only be programmed using User Function 9 (see above) or via third party RS-232 serial interface utilizing the Allegiant Command Console Language (CCL) commands.

User Function 47 – Six-digit Camera ID

Use this function to enable/disable “6-digit Camera ID” mode. When enabled, 2-digit “site numbers” are displayed in addition to the 4-digit camera number. The 2-digit site number feature is especially useful when groups of cameras are located in separate buildings, floors, or other common areas.

By default, all 6-digit camera numbers are assigned to site “00” and the remaining digits correspond to the standard 4-digit camera numbers. Use the PC-based LTC 8059 Master Control Software to enter unique 6-digit camera numbers for each system camera. When enabled, all keyboard based camera selections and Sequence programming must be done using the 6-digit number.

Once the function is entered, move the joystick up/down to select the desired option. Enter a valid user password, and press [Enter]. The on-screen display of some system monitors may take up to 1 minute before changing.

Note: This feature requires firmware versions released for certain system components in March 2009. If necessary, compare firmware versions against the list of components below to determine if the feature is available in your system:

COMPONENT	Firmware Version
LTC 8x10/01 series CPU/Data Receiver modules	10.05 or later
Intuikey keyboard firmware	1.93 or later
LTC 8555 keyboard firmware	5.90 or later
LTC 8834/00 Video Output Module	3.30
LTC 8059/00 Master Control Software	2.90

User Function 99 – User Function Index

This function is an index listing of all Keyboard User Functions. Move the joystick up or down to view an abbreviated description of the function number currently shown in the first line of the monitor display. Only those functions available to the user (based on their priority level) will be displayed.

19 Maintenance Information

The Allegiant system has been designed to perform for long periods of time with little or no maintenance. Occasionally the need will arise to clean the keyboard, or replace a fuse. Follow the instructions below if any of these items are required.

19.1 Cleaning the Keyboard

The keyboard may be cleaned whenever deemed necessary simply by temporarily removing it from the system and wiping it with a damp cloth. If a conventional spray type cleaner is required, spray the cloth first, then wipe off the surfaces. Do not use petroleum based cleaners or cleaners containing benzene, trichloroethylene, ammonia or acetone, as these cleaners could damage the plastic surfaces.

19.2 AC Line Voltage Input Selection

The AC line voltage input selector is found on the rear of the equipment bay inside the line cord connector housing. The present input voltage selection will be shown in the window of the connector housing. Remove AC line cord if the setting is incorrect. To change the setting, insert a flat blade screwdriver into the slot located at one end of the connector housing as indicated in the drawing and rotate the screwdriver until the door to the housing opens.

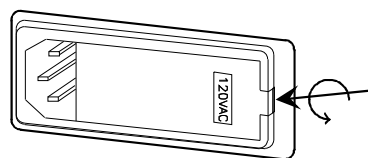

Figure 19: AC line voltage input connector

Remove the voltage selector wheel from the connector housing and rotate until the desired voltage is visible.

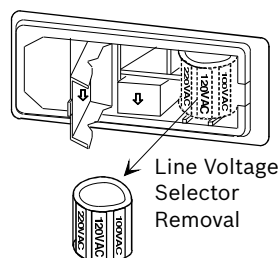

Figure 20: Line voltage selector

Reinsert the wheel back into the connector housing so that the selected voltage is facing out. Snap door closed and verify that the correct voltage selection is visible through the window. Reattach AC line cord.

19.3 AC Line Fuse Replacement

The AC line fuse on Allegiant power supply models is found on the rear of the equipment bay near the line cord connector. Power supply models for 220-240 VAC input version may contain a circuit breaker equipped power switch which can be reset directly from the front. If the line fuse needs to be replaced in a 120 VAC model power supply, remove the line cord from the system. Insert a flat blade screwdriver into the slot located at one end of the connector housing and rotate the screwdriver until the door to the housing opens. Remove fuse holder from housing as shown in drawing.

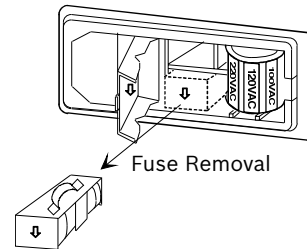

Figure 21: Allegiant power supply AC line fuse

Remove fuse from holder and replace with fuse of same rating for continued protection. Reinstall fuse holder into connector housing in the same orientation as indicated by the arrow on the door cover. Snap door closed. After replacing fuse, verify system start-up and operation.

19.4 Power Supply Fuse Replacement

The main power supply is located in the far right side of the equipment bay. Remove the front panel of the bay by loosening the four fasteners. Locate the fuse to be replaced by observing the green LED indicators. Note which LED indicators are not lit, then turn OFF the main power switch located on the power supply. Replace fuses associated with LEDs which were not lit. Switch on the main power switch and verify that all LEDs are now lit. Replace front panel.

19.5 Replacement of Memory Backup Batteries

General operational notes

- Low battery conditions are indicated by LED on CPU and on-screen flashing “?? ?? ??” of time/date fields.
- Battery status can be check by keyboard operator using Keyboard User Function 43.
- Batteries are checked by CPU once per day at midnight, upon power up, and after system reset.
- If batteries are replaced without power off/on (of at least 10 seconds) or reset of CPU, LED and on-screen indicators will not display normal until next midnight is reached.

CAUTION Lithium batteries should be replaced by qualified service personnel only.

The memory backup batteries are located on the main CPU card located next to the power supply module in the main CPU bay. The batteries provide RAM memory backup for a period of at least one year. They are only active when main AC power to the system has been lost. The RAM memory is used to store system operational data

which is frequently changing, including time/date and system crosspoint data (i.e., which camera is currently being displayed on which monitor). More vital system data such as camera titles, alarm settings, user information and passwords, etc. is stored in non-volatile memory that is not affected by the condition of the batteries or the main AC power.

Remove the front panel of the main CPU bay by loosening the four fasteners. The two batteries are mounted on the front edge of the CPU card and are about 25 mm (1 in.) in diameter. Insert a small flat blade screwdriver into the slot on one of the battery holder sockets and gently pry the battery from the holder until it can be removed by your fingers. Replace old battery with new battery by lifting the retaining clip up while inserting the battery into the socket. Insure that the negative side of the battery contacts the socket by seating the battery until it is somewhat flush with the level of the battery holder. Repeat procedure for other battery.

Verification of the system's time and date and sequence programming should be made to insure no information was lost. Refer to the appropriate section of the instruction manual if any reprogramming is required.

20 Character ROM Tables for LTC 8600 and LTC 8800

The characters used in generating the video monitor displays are shown in the table on the following pages. Note that in some cases, a single character may be comprised of two (2) parts. Such characters must be entered so that the left half of the character always begins in an odd numbered column of the display title. The code numbers of these double-width characters are shown in black boxes in the table below. Refer to the section of the operating instructions covering "User Functions" for title programming procedures.

						C A	M A	M L	R L	A S	R S	£	¤	£	¤	D M	S M						
0	1	2	3	4	5	6	7	8	9	10	11	12	13	14	15	16	17	18	19	20	21	22	23
									!	"	#	\$	%	&	'	()	*	+	,	-	.	/
24	25	26	27	28	29	30	31	32	33	34	35	36	37	38	39	40	41	42	43	44	45	46	47
0	1	2	3	4	5	6	7	8	9	:	;	<	=	>	?	@	A	B	C	D	E	F	G
48	49	50	51	52	53	54	55	56	57	58	59	60	61	62	63	64	65	66	67	68	69	70	71
H	I	J	K	L	M	N	O	P	Q	R	S	T	U	V	W	X	Y	Z	[\]	^	_
72	73	74	75	76	77	78	79	80	81	82	83	84	85	86	87	88	89	90	91	92	93	94	95
'	a	b	c	d	e	f	g	h	i	j	k	l	m	n	o	p	q	r	s	t	u	v	w
96	97	98	99	100	101	102	103	104	105	106	107	108	109	110	111	112	113	114	115	116	117	118	119
x	y	z	{		}	~	Δ	Ç	ü	é	â	ä	à	ã	ç	ê	ë	è	ÿ	î	ì	Ä	Å
120	121	122	123	124	125	126	127	128	129	130	131	132	133	134	135	136	137	138	139	140	141	142	143
É	æ	ff	ô	ö	ò	û	ù	ÿ	ø	ü	ç	£	¥	℞	f	á	í	ó	ú	ñ	Ñ	º	º
144	145	146	147	148	149	150	151	152	153	154	155	156	157	158	159	160	161	162	163	164	165	166	167
¿	Γ	Γ	½	¼	¡	«	»	▨	▩	▪		†	‡	§	¶	¶	¶	¶	¶	¶	¶	¶	¶
168	169	170	171	172	173	174	175	176	177	178	179	180	181	182	183	184	185	186	187	188	189	190	191
L	L	T	†	-	†	†						=		±		T	π		£	F	π		
192	193	194	195	196	197	198	199	200	201	202	203	204	205	206	207	208	209	210	211	212	213	214	215
†	J	Γ	■	■	■	■	■	α	β	Γ	π	Σ	σ	μ	γ	ø	θ	Ω	δ	ω	ø	€	Π
216	217	218	219	220	221	222	223	224	225	226	227	228	229	230	231	232	233	234	235	236	237	238	239
≡	±	≥	≤	∫	J	÷	≈	°	.	.	J	n	z	■			⊗	⊗	♥	♦	♦	♦	•
240	241	242	243	244	245	246	247	248	249	250	251	252	253	254	255	256	257	258	259	260	261	262	263
◻	◻	◻	♂	♀	ℙ	ℙ	*	▶	◀	↑	!!	¶	§	-	±	↑	↓	→	←	↳	↔	▲	▼
264	265	266	267	268	269	270	271	272	273	274	275	276	277	278	279	280	281	282	283	284	285	286	287

288	289	290	291	292	293	294	295	296	297	298	299	300	301	302	303	304	305	306	307	308	309	310	311
312	313	314	315	316	317	318	319	320	321	322	323	324	325	326	327	328	329	330	331	332	333	334	335
336	337	338	339	340	341	342	343	344	345	346	347	348	349	350	351	352	353	354	355	356	357	358	359
360	361	362	363	364	365	366	367	368	369	370	371	372	373	374	375	376	377	378	379	380	381	382	383
384	385	386	387	388	389	390	391	392	393	394	395	396	397	398	399	400	401	402	403	404	405	406	407
408	409	410	411	412	413	414	415	416	417	418	419	420	421	422	423	424	425	426	427	428	429	430	431
432	433	434	435	436	437	438	439	440	441	442	443	444	445	446	447	448	449	450	451	452	453	454	455
456	457	458	459	460	461	462	463	464	465	466	467	468	469	470	471	472	473	474	475	476	477	478	479
480	481	482	483	484	485	486	487	488	489	490	491	492	493	494	495	496	497	498	499	500	501	502	503
504	505	506	507	508	509	510	511	512	513	514	515	516	517	518	519	520	521	522	523	524	525	526	527
528	529	530	531	532	533	534	535	536	537	538	539	540	541	542	543	544	545	546	547	548	549	550	551
552	553	554	555	556	557	558	559	560	561	562	563	564	565	566	567	568	569	570	571	572	573	574	575

W	X	Y	Z	a	b	c	d	e	f	g	h	i	j	k	l	m	n	o	p	q	r	s	t
576	577	578	579	580	581	582	583	584	585	586	587	588	589	590	591	592	593	594	595	596	597	598	599
u	v	w	x	y	z	()	在	子	字	左	直	制	終	指	中	正	終	安	白	北	闭	宾
600	601	602	603	604	605	606	607	608	609	610	611	612	613	614	615	616	617	618	619	620	621	622	623
測	长	场	朝	城	车	程	传	大	导	道	灯	第	地	低	电	点	端	队	都	东	港	高	各
624	625	626	627	628	629	630	631	632	633	634	635	636	637	638	639	640	641	642	643	644	645	646	647
阁	关	管	馆	故	国	光	工	公	共	海	好	后	候	紅	欢	环	半	挥	会	湖	机	級	技
648	649	650	651	652	653	654	655	656	657	658	659	660	661	662	663	664	665	666	667	668	669	670	671
际	计	家	加	间	监	检	建	交	进	街	究	局	經	京	开	科	口	控	里	理	立	樓	路
672	673	674	675	676	677	678	679	680	681	682	683	684	685	686	687	688	689	690	691	692	693	694	695
烏	南	前	区	人	攝	市	头	通	外	西	系	綫	像	小	右	与	乡	业	务	讯	团	会	齐
696	697	698	699	700	701	702	703	704	705	706	707	708	709	710	711	712	713	714	715	716	717	718	719
兴	红	进	劳	财	島	沟	环	国	线	铁	辆	灣	镇	亞	阿	愛	逢	或	院	陰	隱	吋	右
720	721	722	723	724	725	726	727	728	729	730	731	732	733	734	735	736	737	738	739	740	741	742	743
雨	運	橫	欧	王	黄	屋	乙	卸	恩	温	穩	音	下	化	械	海	界	開	外	崖	街	寒	官
744	745	746	747	748	749	750	751	752	753	754	755	756	757	758	759	760	761	762	763	764	765	766	767
干	幹	感	機	汽	規	記	貴	起	軌	騎	技	供	共	協	境	強	橋	況	群	軍	啓	型	賢
768	769	770	771	772	773	774	775	776	777	778	779	780	781	782	783	784	785	786	787	788	789	790	791
鍵	顯	驗	元	原	源	后	好	工	巷	控	校	江	叉	左	沙	捌	三	參	山	產	算	磁	示
792	793	794	795	796	797	798	799	800	801	802	803	804	805	806	807	808	809	810	811	812	813	814	815
七	室	州	拾	洲	秋	週	十	升	哨	商	小	少	廠	招	職	色	信	心	新	安	案	位	委
816	817	818	819	820	821	822	823	824	825	826	827	828	829	830	831	832	833	834	835	836	837	838	839
椅	異	移	維	雲	影	英	衛	液	加	嘉	家	科	架	河	花	華	課	貨	各	核	隔	掛	環
840	841	842	843	844	845	846	847	848	849	850	851	852	853	854	855	856	857	858	859	860	861	862	863

監看管簡緩艦間閱館岸客休宮救業局勤禁緊形徑携景計
 864 865 866 867 868 869 870 871 872 873 874 875 876 877 878 879 880 881 882 883 884 885 886 887
 警輕迎限固庫湖顧五港硬紅航行衝講鋼降坐座載際餐司
 888 889 890 891 892 893 894 895 896 897 898 899 900 901 902 903 904 905 906 907 908 909 910 911
 四子市指支止斜車重出術春照章証診進人訊陣域一引園
 912 913 914 915 916 917 918 919 920 921 922 923 924 925 926 927 928 929 930 931 932 933 934 935
 延遠汚央往駕回快改滑玩眼器基旗期棄級給去近金銀九
 936 937 938 939 940 941 942 943 944 945 946 947 948 949 950 951 952 953 954 955 956 957 958 959
 玖具空月圈建後護交光公口香高合告黑骨材財策視試資
 960 961 962 963 964 965 966 967 968 969 970 971 972 973 974 975 976 977 978 979 980 981 982 983
 字主守酒首準巡初所署傷上城場情推水数世制成政整星
 984 985 986 987 988 989 990 991 992 993 994 995 996 997 998 999 1000 1001 1002 1003 1004 1005 1006 1007
 晴正生西閃前全造側息測速村多達棚谷短端超長頂直天
 1008 1009 1010 1011 1012 1013 1014 1015 1016 1017 1018 1019 1020 1021 1022 1023 1024 1025 1026 1027 1028 1029 1030 1031
 店踏逃頭鬪動同堂導洞道認年八伴半反鼻百票表覆分噴
 1032 1033 1034 1035 1036 1037 1038 1039 1040 1041 1042 1043 1044 1045 1046 1047 1048 1049 1050 1051 1052 1053 1054 1055
 文平法密民務霧名有遊離陸立流路廊樓老六青靜稅石籍
 1056 1057 1058 1059 1060 1061 1062 1063 1064 1065 1066 1067 1068 1069 1070 1071 1072 1073 1074 1075 1076 1077 1078 1079
 接匝掃太帶待泰壇男值池置築通吊電都督巴播霸配倍品
 1080 1081 1082 1083 1084 1085 1086 1087 1088 1089 1090 1091 1092 1093 1094 1095 1096 1097 1098 1099 1100 1101 1102 1103
 賓頁便舖北本明盟儲目預幼洋瞭綠臨雪仙專戰旋穿線槍
 1104 1105 1106 1107 1108 1109 1110 1111 1112 1113 1114 1115 1116 1117 1118 1119 1120 1121 1122 1123 1124 1125 1126 1127
 相裝鎗大室中駐偵訂塔島東棟燈灘南日入買泊飛備尾美
 1128 1129 1130 1131 1132 1133 1134 1135 1136 1137 1138 1139 1140 1141 1142 1143 1144 1145 1146 1147 1148 1149 1150 1151

腐阜武部風副步輔包報峯門欄零裂聯一七九二人入八十
 1152 1153 1154 1155 1156 1157 1158 1159 1160 1161 1162 1163 1164 1165 1166 1167 1168 1169 1170 1171 1172 1173 1174 1175
 三口土大女小山川工中之井五仁元六公分卅尺心手方日
 1176 1177 1178 1179 1180 1181 1182 1183 1184 1185 1186 1187 1188 1189 1190 1191 1192 1193 1194 1195 1196 1197 1198 1199
 月火片王丙丘主仙出凸功北仵可右叫台四外左市平民甲
 1200 1201 1202 1203 1204 1205 1206 1207 1208 1209 1210 1211 1212 1213 1214 1215 1216 1217 1218 1219 1220 1221 1222 1223
 白石立交企危向后地年收兵即坊坑壯宏局岐志李村步系
 1224 1225 1226 1227 1228 1229 1230 1231 1232 1233 1234 1235 1236 1237 1238 1239 1240 1241 1242 1243 1244 1245 1246 1247
 肖邦里防佰兩和周坡定宜岸店往房放昌板河金南威度急
 1248 1249 1250 1251 1252 1253 1254 1255 1256 1257 1258 1259 1260 1261 1262 1263 1264 1265 1266 1267 1268 1269 1270 1271
 政星昱查柒段泉省紅背郊剛峰旁旅桂氣浪斑珠矩站停區
 1272 1273 1274 1275 1276 1277 1278 1279 1280 1281 1282 1283 1284 1285 1286 1287 1288 1289 1290 1291 1292 1293 1294 1295
 商售國將崖排晚清組船處設責途部鳥勞博堡廊廁景氮湖
 1296 1297 1298 1299 1300 1301 1302 1303 1304 1305 1306 1307 1308 1309 1310 1311 1312 1313 1314 1315 1316 1317 1318 1319
 程窗絕註象貳隊黃黑圓塞厦敬溝煤當矮萬置罩肆運遂鉛
 1320 1321 1322 1323 1324 1325 1326 1327 1328 1329 1330 1331 1332 1333 1334 1335 1336 1337 1338 1339 1340 1341 1342 1343
 電團圖漢福精臺領層廣廠輛器應總檯舊轉攝廳觀庄
 1344 1345 1346 1347 1348 1349 1350 1351 1352 1353 1354 1355 1356 1357 1358 1359 1360 1361 1362 1363 1364 1365 1366 1367

1368 1369 1370 1371 1372 1373 1374 1375 1376 1377 1378 1379 1380 1381 1382 1383 1384 1385 1386 1387 1388 1389 1390 1391

1392 1393 1394 1395 1396 1397 1398 1399 1400 1401 1402 1403 1404 1405 1406 1407 1408 1409 1410 1411 1412 1413 1414 1415

1416 1417 1418 1419 1420 1421 1422 1423 1424 1425 1426 1427 1428 1429 1430 1431 1432 1433 1434 1435 1436 1437 1438 1439

在子字左障直制指中正安白北闭宾长常畅场朝城车程
 2048 2049 2050 2051 2052 2053 2054 2055 2056 2057 2058 2059 2060 2061 2062 2063 2064 2065 2066 2067 2068 2069 2070 2071
 传大待寻到道灯等第地低电点端队碓都东港高告各关管
 2072 2073 2074 2075 2076 2077 2078 2079 2080 2081 2082 2083 2084 2085 2086 2087 2088 2089 2090 2091 2092 2093 2094 2095
 故国光工公共海好后候欢环华会湖呼机技际计家加监检
 2096 2097 2098 2099 2100 2101 2102 2103 2104 2105 2106 2107 2108 2109 2110 2111 2112 2113 2114 2115 2116 2117 2118 2119
 建交进街接究局距京开科控快宽里理立离联亮良临楼路
 2120 2121 2122 2123 2124 2125 2126 2127 2128 2129 2130 2131 2132 2133 2134 2135 2136 2137 2138 2139 2140 2141 2142 2143
 门南齐前桥请区人散司塞算所送上摄时使示市视事试输
 2144 2145 2146 2147 2148 2149 2150 2151 2152 2153 2154 2155 2156 2157 2158 2159 2160 2161 2162 2163 2164 2165 2166 2167
 疏术首水提体同通图外西系下先仙香像新小学研央阳窑
 2168 2169 2170 2171 2172 2173 2174 2175 2176 2177 2178 2179 2180 2181 2182 2183 2184 2185 2186 2187 2188 2189 2190 2191
 意已谊因迎有友右由用源园厂万与亿个广义卫飞习马乡
 2192 2193 2194 2195 2196 2197 2198 2199 2200 2201 2202 2203 2204 2205 2206 2207 2208 2209 2210 2211 2212 2213 2214 2215
 开无韦专艺厅历区冈贝见气长市从仓仓风仪凤鸟为忆订
 2216 2217 2218 2219 2220 2221 2222 2223 2224 2225 2226 2227 2228 2229 2230 2231 2232 2233 2234 2235 2236 2237 2238 2239
 计认队办郊助双书击节龙厉灭东轧卢业旧帅归叶号叹们
 2240 2241 2242 2243 2244 2245 2246 2247 2248 2249 2250 2251 2252 2253 2254 2255 2256 2257 2258 2259 2260 2261 2262 2263
 仪丛尔乐处鸟务台邝冯冈兰汇头没宁讨写让礼训讯记辽
 2264 2265 2266 2267 2268 2269 2270 2271 2272 2273 2274 2275 2276 2277 2278 2279 2280 2281 2282 2283 2284 2285 2286 2287
 边发对纠馐丝动执巩扩扫扬亚机权过协压厌页夺达夹轨
 2288 2289 2290 2291 2292 2293 2294 2295 2296 2297 2298 2299 2300 2301 2302 2303 2304 2305 2306 2307 2308 2309 2310 2311
 尧迈毕贞师当尘吓团屿岁则刚网迂乔伟传伤伦华伪会杀
 2312 2313 2314 2315 2316 2317 2318 2319 2320 2321 2322 2323 2324 2325 2326 2327 2328 2329 2330 2331 2332 2333 2334 2335

众爷伞创杂页壮妆庆刘产问闯汤兴讲讳军谍讷许诤论论
 2333 2337 2338 2339 2340 2341 2342 2343 2344 2345 2346 2347 2348 2349 2350 2351 2352 2353 2354 2355 2356 2357 2358 2359
 讽农设访诀寻尽孙阵阳阶阴妇蚂戏观买纭红纭馱纭纭驯
 2360 2361 2362 2363 2364 2365 2366 2367 2368 2369 2370 2371 2372 2373 2374 2375 2376 2377 2378 2379 2380 2381 2382 2383
 纭约级纪驰纭寿麦玛进远速韧运抚坛坏抠砾扰坝贡抡抡
 2384 2385 2386 2387 2388 2389 2390 2391 2392 2393 2394 2395 2396 2397 2398 2399 2400 2401 2402 2403 2404 2405 2406 2407
 坟护壳块声报拟芜苇芸苾苍严芦劳苏极杨两丽医励还矾
 2408 2409 2410 2411 2412 2413 2414 2415 2416 2417 2418 2419 2420 2421 2422 2423 2424 2425 2426 2427 2428 2429 2430 2431
 矸来轩连邨坚时县旷围吨邮员财岗帐针钉乱邻肠龟坞条
 2432 2433 2434 2435 2436 2437 2438 2439 2440 2441 2442 2443 2444 2445 2446 2447 2448 2449 2450 2451 2452 2453 2454 2455
 岛邹任饭饮冻状亩庠疗应这庐闰闲间闷灿灶馐沦沧沟沪
 2456 2457 2458 2459 2460 2461 2462 2463 2464 2465 2466 2467 2468 2469 2470 2471 2472 2473 2474 2475 2476 2477 2478 2479
 怀愆忧沥穷证诃启评补识诈诊词诏译灵层迟张陆陇陈坠
 2480 2481 2482 2483 2484 2485 2486 2487 2488 2489 2490 2491 2492 2493 2494 2495 2496 2497 2498 2499 2500 2501 2502 2503
 鸡纬驱纯纲纵纭纷纸纹纺驴纽纾玮环责现规拢担顶拥势
 2504 2505 2506 2507 2508 2509 2510 2511 2512 2513 2514 2515 2516 2517 2518 2519 2520 2521 2522 2523 2524 2525 2526 2527
 拦拧拨择茺茎枢柝枞枪枫丧画枣卖矾矿码厕奋恣瓯欧殴
 2528 2529 2530 2531 2532 2533 2534 2535 2536 2537 2538 2539 2540 2541 2542 2543 2544 2545 2546 2547 2548 2549 2550 2551
 堇邦顷转斩轮软鸯齿贤县罗帜凯峰败账贩贮购钎钓侠侦
 2552 2553 2554 2555 2556 2557 2558 2559 2560 2561 2562 2563 2564 2565 2566 2567 2568 2569 2570 2571 2572 2573 2574 2575
 侧凭赁质径觅贫鱼备饩饰饱饲饴变庞庙剂废闸闹郑单炜
 2576 2577 2578 2579 2580 2581 2582 2583 2584 2585 2586 2587 2588 2589 2590 2591 2592 2593 2594 2595 2596 2597 2598 2599
 浅泻泼泽泾宝宠审帘实试诗谈诚衬视诛话诞询诣该详诩
 2600 2601 2602 2603 2604 2605 2606 2607 2608 2609 2610 2611 2612 2613 2614 2615 2616 2617 2618 2619 2620 2621 2622 2623

肃隶录弥陕驾参艰线练组绅细驶附驹驹终织绉驻绊驼绌
 2624|2625|2626|2627|2628|2629|2630|2631|2632|2633|2634|2635|2636|2637|2638|2639|2640|2641|2642|2643|2644|2645|2646|2647
 绍驿绎经贯贰帮项挠赵挡垫挤挥莢带芥荣茆药标棧柝栏
 2648|2649|2650|2651|2652|2653|2654|2655|2656|2657|2658|2659|2660|2661|2662|2663|2664|2665|2666|2667|2668|2669|2670|2671
 柠树砖砚牵鸥残轱轲轳轴轶轻战览竖尝显贵虾蚁蚂虽刚
 2672|2673|2674|2675|2676|2677|2678|2679|2680|2681|2682|2683|2684|2685|2686|2687|2688|2689|2690|2691|2692|2693|2694|2695
 郦勋响峡顿罚贴钞钟钢钠钥钧钩钊氩选适狱贺饺饼峦弯
 2696|2697|2698|2699|2700|2701|2702|2703|2704|2705|2706|2707|2708|2709|2710|2711|2712|2713|2714|2715|2716|2717|2718|2719
 将奖亲枫围笃俩贷顺剑须臆胆狮独闻闻阁阁阐养类娄总
 2720|2721|2722|2723|2724|2725|2726|2727|2728|2729|2730|2731|2732|2733|2734|2735|2736|2737|2738|2739|2740|2741|2742|2743
 烁烂浇浊测浏济泽浒浓恼举宪窃讽语袂误诱诲说诵垦昼
 2744|2745|2746|2747|2748|2749|2750|2751|2752|2753|2754|2755|2756|2757|2758|2759|2760|2761|2762|2763|2764|2765|2766|2767
 费险贺垒绕娇郷绒结晓绕骄绘咯骈绞骇统给绉络绝艳顽
 2768|2769|2770|2771|2772|2773|2774|2775|2776|2777|2778|2779|2780|2781|2782|2783|2784|2785|2786|2787|2788|2789|2790|2791
 盍捞载盐损坝捡挚热壶曩莱莲恶莹栲档桦栓桩样贾础顾
 2792|2793|2794|2795|2796|2797|2798|2799|2800|2801|2802|2803|2804|2805|2806|2807|2808|2809|2810|2811|2812|2813|2814|2815
 轿较顿鸬虑紧晓鸭晕唠罢圆赋赃钱钳铁铃铅敌积称笔债
 2816|2817|2818|2819|2820|2821|2822|2823|2824|2825|2826|2827|2828|2829|2830|2831|2832|2833|2834|2835|2836|2837|2838|2839
 倾赁舰枪瓮爱颁脏脑胶栾恋浆浆斋资竟阅郾烦烧烛递涛
 2840|2841|2842|2843|2844|2845|2846|2847|2848|2849|2850|2851|2852|2853|2854|2855|2856|2857|2858|2859|2860|2861|2862|2863
 沸涑涟滦润润涨逦涩宽冥窍请诸读课谁调谅谈谊息剧难
 2864|2865|2866|2867|2868|2869|2870|2871|2872|2873|2874|2875|2876|2877|2878|2879|2880|2881|2882|2883|2884|2885|2886|2887
 预骋绢绣验绦继唆煮琐擲摔据掺攢职营萧萨梦硕糞辅辆
 2888|2889|2890|2891|2892|2893|2894|2895|2896|2897|2898|2899|2900|2901|2902|2903|2904|2905|2906|2907|2908|2909|2910|2911

蛰悬跃蛭崭逦赈婴踪铸铝铜银萇笮衅盘瓮鸽颌脸猎馆盖
 2912 2913 2914 2915 2916 2917 2918 2919 2920 2921 2922 2923 2924 2925 2926 2927 2928 2929 2930 2931 2932 2933 2934 2935
 断兽鸿渐渑渊渔惭惯禘谶谋谎谐裆祸谓谛弹隐蚺颈绩绪
 2936 2937 2938 2939 2940 2941 2942 2943 2944 2945 2946 2947 2948 2949 2950 2951 2952 2953 2954 2955 2956 2957 2958 2959
 续骑绳雎维绵综绽绿琼犳趋揽撙揽蒋韩楠确暂辈凿辉赏
 2960 2961 2962 2963 2964 2965 2966 2967 2968 2969 2970 2971 2972 2973 2974 2975 2976 2977 2978 2979 2980 2981 2982 2983
 喷践遗赐铸铺储惩释鲁网鳇销锁锈锋锐筑装奁阔糞窝愤
 2984 2985 2986 2987 2988 2989 2990 2991 2992 2993 2994 2995 2996 2997 2998 2999 3000 3001 3002 3003 3004 3005 3006 3007
 滞湿溅湾谢谣谦属纆緝緞缓编缘摆摊蓝蓟颐献揽桐赖碍
 3008 3009 3010 3011 3012 3013 3014 3015 3016 3017 3018 3019 3020 3021 3022 3023 3024 3025 3026 3027 3028 3029 3030 3031
 霎辐辑频错锤锦辞筹筌筒颖雒眷粮斲满滤滥滦滨滩蹇缚
 3032 3033 3034 3035 3036 3037 3038 3039 3040 3041 3042 3043 3044 3045 3046 3047 3048 3049 3050 3051 3052 3053 3054 3055
 缝缠缤墙槛殡殡辖镀稳箩箫鲜饘潇淮蹇谭谱缥嘌嘌縲缩
 3056 3057 3058 3059 3060 3061 3062 3063 3064 3065 3066 3067 3068 3069 3070 3071 3072 3073 3074 3075 3076 3077 3078 3079
 缪撵聪樱飘辄题踟嚅嘱镇颜颌鹤颠匱赠鏢镜辩缴辩羸懋
 3080 3081 3082 3083 3084 3085 3086 3087 3088 3089 3090 3091 3092 3093 3094 3095 3096 3097 3098 3099 3100 3101 3102 3103
 蹶鸩颤贲逢握宛或院宇雨云旺横王翁黄屋牡乙卸恩温音
 3104 3105 3106 3107 3108 3109 3110 3111 3112 3113 3114 3115 3116 3117 3118 3119 3120 3121 3122 3123 3124 3125 3126 3127
 化何械界概冠寒官干感敢汽季鬼供境强熊群郡刑型遣元
 3128 3129 3130 3131 3132 3133 3134 3135 3136 3137 3138 3139 3140 3141 3142 3143 3144 3145 3146 3147 3148 3149 3150 3151
 原玄孝宏巧巷康恒慌拘攻杭校构江洪今困婚昏根沙察擦
 3152 3153 3154 3155 3156 3157 3158 3159 3160 3161 3162 3163 3164 3165 3166 3167 3168 3169 3170 3171 3172 3173 3174 3175
 晒三山撒蚕磁而鹿七室就州愁拾洲秀秋集十匠召商唱宵
 3176 3177 3178 3179 3180 3181 3182 3183 3184 3185 3186 3187 3188 3189 3190 3191 3192 3193 3194 3195 3196 3197 3198 3199

少庄彰抄招捷昌植色触食信心慎振晋申暗案以位威慰易
 移影映永英液疫益越佳可果架歌河花垣郭隔革岳甘看岸
 吉却客脚丘久休救仰斤琴禁形敬景桂警限固胡雇鼓五甲
 皇硬耕行衡郊降座再最裁酸史四志思支止斜者遮柔重视
 熟出春瞬竣准循沼湘焦照省肖神辛震迅厨井域育引援沿
 烟燕苑奥往我雅解回改茅玩眼岩雁喜基奇旗期棋牛去近
 金九句空偶寓遇激血月圈御功忽材坂昨栅窄策紫至寺寂
 主守朱珠种酒需周遵初暑女徐丈睡随嵩世是征成政整晴
 清精船禅臧蔽造息速俗族村多但棚谷短超跳鼎泥摘滴撤
 典天店豆堂撞洞如年燃粘乃之能箱八半反百漂票表福複
 分焚文兵平法坊妨忙房暴望味密湊民名佑勇融夕立流溜
 旅露廊朗狼老六醒静税石赤祖租阻宋匝搜太戴泰暖段知

智池竹蓄沈珍津追坪吊殿渡度土党冬得德特屯播牌背配
 8488 8489 8490 8491 8492 8493 8494 8495 8496 8497 8498 8499 8500 8501 8502 8503 8504 8505 8506 8507 8508 8509 8510 8511
 倍梅搬板班晚苗富府片篇遍便防墨没本翻棉模毛蒙目摇
 8512 8513 8514 8515 8516 8517 8518 8519 8520 8521 8522 8523 8524 8525 8526 8527 8528 8529 8530 8531 8532 8533 8534 8535
 洋洋要遥凉量和雪槽争相走增台只茶柱注丁停定帝庭廷
 8536 8537 8538 8539 8540 8541 8542 8543 8544 8545 8546 8547 8548 8549 8550 8551 8552 8553 8554 8555 8556 8557 8558 8559
 梯塔塘搭桃答二日入漠碑避微美普武葡部墓簿奉峰放方
 8560 8561 8562 8563 8564 8565 8566 8567 8568 8569 8570 8571 8572 8573 8574 8575 8576 8577 8578 8579 8580 8581 8582 8583
 朋磨麻埋幕亦又慢柳淀螺雷落璃裂一尸尹尺火乍卉卯孕
 8584 8585 8586 8587 8588 8589 8590 8591 8592 8593 8594 8595 8596 8597 8598 8599 8600 8601 8602 8603 8604 8605 8606 8607
 尼瓦兵圳圭夷宅汕舌舟佛冶劫吾呈囤坎尾岔彤役抑旱杖
 8608 8609 8610 8611 8612 8613 8614 8615 8616 8617 8618 8619 8620 8621 8622 8623 8624 8625 8626 8627 8628 8629 8630 8631
 沐甬甸皂邢卓珂抛昔丁刀力刃士寸巾才不丰互允内冗切
 8632 8633 8634 8635 8636 8637 8638 8639 8640 8641 8642 8643 8644 8645 8646 8647 8648 8649 8650 8651 8652 8653 8654 8655
 匀勿匹午孔户扎斗木欠比付代令充册凹卡占古另史失它
 8656 8657 8658 8659 8660 8661 8662 8663 8664 8665 8666 8667 8668 8669 8670 8671 8672 8673 8674 8675 8676 8677 8678 8679
 巨布必打扒扑未末犯玉甩田皮伍伏伴任份列划印吃存式
 8680 8681 8682 8683 8684 8685 8686 8687 8688 8689 8690 8691 8692 8693 8694 8695 8696 8697 8698 8699 8700 8701 8702 8703
 扣扛曲次灰米自衣串住伺伸作兑克免别判删刨助吞否呆
 8704 8705 8706 8707 8708 8709 8710 8711 8712 8713 8714 8715 8716 8717 8718 8719 8720 8721 8722 8723 8724 8725 8726 8727
 吹吸址均序床戒抄抖扶把批扳折投更束杆杠求沉决冲牢
 8728 8729 8730 8731 8732 8733 8734 8735 8736 8737 8738 8739 8740 8741 8742 8743 8744 8745 8746 8747 8748 8749 8750 8751
 私角身那采並侍例佩其券刷刺刮取受命垃夜始宗居底念
 8752 8753 8754 8755 8756 8757 8758 8759 8760 8761 8762 8763 8764 8765 8766 8767 8768 8769 8770 8771 8772 8773 8774 8775

承拉拌抽押抱拖拆服朋林杯松泳沽沾波泄油治炒炊爬版
 377637773778377937803781378237833784378537863787378837893790379137923793379437953796379737983799
 物的孟社股卧舍返邵附非亭侵保俞完刹匍厚咨垂契封屏
 380038013802380338043805380638073808380938103811381238133814381538163817381838193820382138223823
 律扁按拼括拴挑施柿枯柄柑柚歪毒洗活洽派泵玻甚盆砂
 382438253826382738283829383038313832383338343835383638373838383938403841384238433844384538463847
 砍禹禹秒缸范面食乘毫借俱修兼剖剔剝埂埔夏套容射展
 384838493850385138523853385438553856385738583859386038613862386338643865386638673868386938703871
 峪差弱悟悍扇捕捆挽效料晌朔桌栽柴桐格株栓殊殉消浙
 387238733874387538763877387838793880388138823883388438853886388738883889389038913892389338943895
 涉浴烘留皋眨矩砸破祠崇秤秘粉紗素索缺羔耘茫荔荆荐
 389638973898389939003901390239033904390539063907390839093910391139123913391439153916391739183919
 草袁起逆迷退陡除乾假做健偕偏區啤堆堵孰宿崛庸彩探
 392039213922392339243925392639273928392939303931393239333934393539363937393839393940394139423943
 措捶掉教晨梁椰添混深淮淄焊犁率球痕盆盛硫符粗脱莘
 394439453946394739483949395039513952395339543955395639573958395939603961396239633964396539663967
 荷被袋口逐透陪陵章割喘喻堤堡壹媒嵌彭惠慨掌揩换敞
 396839693970397139723973397439753976397739783979398039813982398339843985398639873988398939903991
 斯晾曾替森棒款游渠渣減湛渤渝溉皖窖絮翔菩菱趁逸鄂
 399239933994399539963997399839994000400140024003400440054006400740084009401040114012401340144015
 酥隋陞黑催勤塑厦搭椰榆溯滇溪矮碎粳粵聘肆葵蜀衙雍
 401640174018401940204021402240234024402540264027402840294030403140324033403440354036403740384039
 嘉墅樹翟蓉需僻墟墩撞潼磅碾磐箱蔬趟踪冀壁操融隧霍
 404040414042404340444045404640474048404940504051405240534054405540564057405840594060406140624063
 餐疆蘑霸价垛洒种涂滯
 406440654066406740684069407040714072407340744075407640774078407940804081408240834084408540864087

21 ERROR MESSAGES

- **Error 01 - Invalid camera request**
The camera number entered from the keyboard does not exist. If using the optional LTC 8850 GUI Software or the optional LTC 8059 MCS, make sure the number exists in the Camera Identification Table. Download the table to be sure.
- **Error 02 - Invalid monitor request**
The monitor number entered from the keyboard does not exist. Enter a valid monitor number.
- **Error 03 - Locked remote device**
The remote device requested cannot be controlled because it is locked by a user with equal or higher priority. Check with the other users or request that a higher priority user unlock the remote device.
- **Error 04 - Monitor locked**
The monitor requested cannot be accessed because it is locked by a user with equal or higher priority. Check with the other users or request that a higher priority user unlock the monitor.
- **Error 05 - Remote device access restricted**
Remote locked out by Remote Lockout Table.
- **Error 06 - Monitor Access Restricted**
Monitor locked out by Monitor Lockout Table.
- **Error 10 - Access denied**
A function was requested that requires a higher user priority. Only a Priority 2 user or a supervisor with Priority 1 may access this function.
- **Error 11 - Access denied**
A function was requested for which your user priority is too low. Only a supervisor with Priority 1 may access this function.
- **Error 15 - Invalid user function**
The function number requested from the keyboard is invalid. Refer to the User Function Table for a listing of the valid user function numbers.
- **Error 20 - Acknowledge denied**
The ACKNOWLEDGE button has been pressed by a user without the authority to acknowledge alarms.
- **Error 21 - Incorrect acknowledge**
In order to properly acknowledge an alarm event, the keyboard must be switched to a monitor that is displaying the alarms.
- **Error 22 - Acknowledge disabled**
Alarms on this monitor can not be acknowledged, because that capability has been disabled by the system programmer.
- **Error 23 - Camera not in alarm**
The camera displayed on the monitor is not an alarm video; only alarm-generated video can be acknowledged.
- **Error 24 - Keyboard not enabled for acknowledge**
This keyboard may not acknowledge alarm video on this monitor; it has been disabled by the system programmer.

- **Error 25 - Alarm switcher running**
Alarm video may only be acknowledged if the alarm switcher is not running; press [HOLD] to stop the switcher.
- **Error 50 - SEQUENCE not available**
The user tried to load a switcher sequence that does not exist. This is a good way to tell from the keyboard which sequence numbers are unused when desiring to add one.
- **Error 51 - SEQUENCE request**
A request was made to load an ABSOLUTE type sequence without the keyboard being on one of the monitors in that sequence. Because inadvertent loading of monitors should be avoided, the user is required to switch his keyboard to one of the monitors used by the sequence. The PROGRAM mode may be used to review what monitors are used in the sequence.
- **Error 52 - SEQUENCE request**
A request was made to load a RELATIVE type sequence on too high of a monitor number; the monitors used by the sequence would extend past the highest monitor. Try switching to a lower monitor number before Loading the sequence.
- **Error 53 - Switcher empty**
The user has tried to control a sequence using the NEXT, PREV, RUN, or HOLD keys without there being a sequence loaded.
- **Error 55 - SEQUENCE priority**
The switcher sequence being requested or cleared requires monitors that are in use by a user of equal or higher priority. Contact a user with higher priority or have the system administrator clear the monitors in question.
- **Error 56 - SEQUENCE request**
The user has tried to load a sequence that is being edited in the PROGRAM mode. Once editing is completed, the sequence may be loaded.
- **Error 58 - SEQUENCE request**
The sequence being requested is a relative sequence, and the user is only allowed access to absolute sequences.
- **Error 60 - PROGRAM request**
The user has tried to program a sequence that is currently running. The sequence must first be stopped before any editing can be performed.
- **Error 62 - PROGRAM request**
The user has tried to program a new sequence when the system is out of sequence memory space. Delete unused sequences and then program the new sequence.
- **Error 63 - PROGRAM request**
Some other user is already programming a sequence on this monitor.
- **Error 70 - Monitor not allocated to alarm monitor group**
This monitor can not be used for alarm operations; it has not been designated as alarm-capable by the system programmer.
- **Error 71 - Step monitor required**
A group of alarm monitors may not have an armed Review (display) monitor without having armed Step (sequence) monitors.
- **Error 78 - Must enter alarm number**
A specific alarm number must be entered when arming or disarming an alarm.

- **Error 80 - Trunk not available**
An attempt was made to access a remote camera connected to a satellite system, but no unused trunk lines are currently available. Depending on system configuration and certain user options, the operator's monitor may automatically switch to the default camera programmed into the Start-up column of the Monitor Table when this error occurs.
- **Error 81 - Satellite Trunk Seized**
The camera currently viewed has changed because an operator with a higher priority has selected a different camera that seized the trunk line from the satellite. The operator's monitor will automatically be switched to the default camera programmed into the Start-up column of the Monitor Table.
- **Error 89 - internal stack error**
A stack overflow within the system has occurred. Report this to the manufacturer.
- **Error 90 - Keyboard entry undefined**
The keyboard entry is not defined. Check the appropriate section of the instruction manual for the desired operation and try again.
- **Error 92 - Keyboard entry out of range**
The data entered for a valid command was not in the range allowed by the system. Check the appropriate section of the instruction manual for the acceptable ranges for the command in question and try again.
- **Error 94 - Keyboard entry invalid**
An invalid character has been received from the keyboard. Usually this would indicate a communications error. Verify that the keyboard-to-system cable is not producing an intermittent connection.
- **Error 95 - Keyboard entry incomplete**
The control sequence sent from the keyboard was incomplete. Usually this would indicate a communications error. Verify that the keyboard-to-system cable is not producing an intermittent connection.
- **Error 96 - * (STAR) undefined**
The * key has been pressed, but there is no definition for this button.

Warning Messages

- **Hi/Low Temperature Alert**
The Allegiant CPU is equipped with a temperature sensor. If the ambient CPU temperature drops below -10 degrees C or goes above +55°C, an on-screen "Temperature Alert" message will appear on the system monitors and the system keyboards will begin to beep.

22 Troubleshooting Guide

The Allegiant system has been designed to perform reliably for long periods of time. All circuitry consists of state-of-the-art components designed around a modular concept. The modular concept allows quick location and replacement of suspect circuits. If system troubleshooting becomes necessary, follow the guidelines:

22.1 Main Bay Checkout

1. Main power switch is ON and power LED indicator is not lit: Check main line fuse on rear of main bay. Refer to Maintenance Information Section for replacement instructions.
2. Any of the green LED indicators located on the front of the main power supply is out: Replace blown fuses associated with any unit fuse indicators.
3. The CPU contains several LEDs that are used to indicate its health and status. Please refer to chart below for details:

LED Name	Functional Description / Troubleshooting Information
CPU ACT.	Random green blinking indicates normal CPU activity. If always ON or always OFF, the CPU is not functioning due to a serious problem with the CPU or the system power supply.
BATT LOW	Lights red to indicate low or dead CPU battery condition. Replace batteries, per procedure described in Maintenance Information section.
TEMP CRIT	Lights red to indicate extremely high or extremely low CPU temperature condition. This would occur if the system is installed in an unsuitable environment or if there is a serious fault with the CPU causing it to overheat.
LAN LINK/ACT	Not used.
LAN 100BASET	Not used.
LAN DUP/COL	Not used.
SDU ACT	Random green flashing indicates control data is being sent out Biphase port.
CONSOLE	Lights green to indicate device is attached to system RS-232 CONSOLE port.
PRINTER	Lights green to indicate device is attached to system RS-232 PRINTER port.
ALARM	Lights green to indicate device is attached to system RS-232 ALARM port.
LED1	Lights RED when data is being written to FLASH memory. This would occur whenever changes are made to user-defined settings, such as camera title programming, alarm table re-configurations, downloads from Master Control Software, etc.
LED2	Not used.
LED3	Not used.
LED4	Not used.
LED5	Not used.
LED6	Not used.
LED7	Not used.
LED8	Random green blinking indicates normal keyboard polling communication activity. If not blinking, it would indicate a problem with the CPU.

4. Intermittent video output or system operation: Verify all circuit card modules are properly seated in their respective rack connectors.
5. Power Supply LEDs lit, but no power indication on modules or accessory devices: Verify proper seating of power supply within the card cage. Verify that supplied retaining screws are installed.

22.2 Keyboard Checkout

1. No keyboard display indicators: Check interconnect cable for cut or broken wires between keyboard and main CPU bay. Replace cable if necessary. Relocate keyboard connector on main CPU bay to another keyboard input port. Replace keyboard.
2. Keyboard indicators lit but keyboard is inoperative: Verify keyboard is logged-on to the system (if log-on feature has been enabled). Check interconnect cable for cut or broken wires between keyboard and main CPU bay. Replace cable if necessary. Relocate keyboard connector on main CPU bay to another keyboard input port. Replace keyboard.
3. Limited keyboard functions: If possible, perform a local keyboard test to verify operation of all keys. See Chapter 15, “User Information,” on page 56. If a local test cannot be performed, replace the keyboard.

Users of the optional LTC 8850 GUI Software or the optional LTC 8059 MCS package should refer to lockout tables to determine if problem is related to user restriction tables. If table settings are verified and no discrepancies are found, replace keyboard.

4. Keyboard Joystick not centered: If the analog joystick of the system keyboard becomes un-centered due to normal wear, it can be re-calibrated. If using the IntuiKey keyboard, go to the Keyboard Control menu and press [Joystick Auto Calibrate]. If using the LTC 8555 Series keyboard, refer to the User Function 1 procedure. (See Chapter 15, “User Information,” on page 56).

22.3 Video Monitor Display Checkout

1. No video display on any monitor: Verify proper CPU operation as described above under Main Bay Checkout Section.
2. No video display on some monitors: Verify operational camera is selected on suspect monitors. Confirm monitor is operational. Check monitor coax connections. Verify coax connection to correct monitor output on rear of main bay. Replace video output module.
3. Poor video on monitor: Check monitor for proper termination. Check operation of known good camera directly to monitor.
4. Partial or no on-screen alphanumeric display: Check user selectable brightness feature (via USER 5 keyboard function) and then verify alphanumeric display has been enabled (via USER 6 keyboard function). Position the overlay with USER 4 function.
5. Time and Date portion of the on-screen display alternates with “?? ?? ??”, and the LED on the front panel indicates a low battery condition: Replace CPU batteries.

22.4 Remote Receiver/Driver Functions Inoperative

1. All receiver/drivers and functions inoperative: Verify power LED indicator on Signal Distribution Unit is lit. If not, check fuses on front of main CPU bay power supply. Verify the Code LED indicator flickers when control is activated by the keyboard. If not, replace Signal Distribution Unit.
2. Individual receiver/driver non-operative: Check green LED indicator on fuse bracket in receiver/driver box. This signifies that AC power is applied by the keyboard. If not, check shielded-twisted-pair cable between Signal Distribution Unit and receiver/driver box. Confirm camera address setting in receiver/driver corresponds to same camera number as selected by the keyboard. Perform internal receiver/driver local test to verify operation of receiver/driver circuitry and pan/tilt/zoom wiring.
3. AutoDome series dome cameras are not operating in a variable speed fashion: Verify CPU DIP switch 7 is selected for variable speed mode.

22.5 No Alarm Response

1. No system alarms operative: Verify power LED indicator on Alarm Interface Unit is lit. If not, check fuses on front of main CPU bay power supply. Verify the Alarm LED indicator lights and the audible buzzer sounds (if enabled) only when an 'alarm' is applied to the unit. If not, replace Alarm Interface unit.
2. Individual cameras/monitors not responding when alarmed: Ensure desired cameras are properly armed on the appropriate armed monitors in the system. Verify alarming device and cable to Alarm Interface unit intact.
3. Incorrect system alarm response: Verify that the desired alarm response mode has been selected. Refer to the section on Select User Functions for instructions.

22.6 CPU Software Version Numbers

During the evolution of the system, there have been various CPU software versions released. In certain troubleshooting cases, Factory Technical Support personnel may ask for the version of the CPU. If it becomes necessary to obtain a CPU software version number, follow the steps below:

CPUs supplied in systems sold after 1995 (having 1, 2, or 3 8-position DIP switches):

1. Using a system keyboard, an operator with a level 1 priority can enter keyboard User Function 23. Press the [User] key. Enter 23 using the numeric keypad, then press the [Enter] key.
2. The CPU version numbers will be displayed on the overlay of the monitor currently being controlled by the keyboard. Record number for future reference.

Very Old or current CPU Versions (having 1 or 2 8-position DIP switches):

1. Remove the front panel of the main CPU bay by loosening the four corner fasteners.
2. Turn OFF main AC power switch on power supply.
3. The CPU module is located next to the power supply. Pull out CPU module from the card cage until IC's containing white labels are visible. The white labels contain copyright information and software version numbers. Record all numbers from label for future reference.
4. Re-install the CPU module and switch ON main AC power.
5. Re-attach front panel.

23 GLOSSARY OF TERMS

Auxiliary

An auxiliary is an additional function of the remote receiver/driver which permits on/off control of outputs available to the user. In the Allegiant system, there are four relay outputs available which can be configured for contact closures, 24 VAC output, or LINE voltage output. They can also be set to activate either momentarily or in a latching mode.

Command Script

A unique feature of the Allegiant system wherein a section of nonvolatile memory can be used to store specialized user-defined programming. A program of this type could then provide custom features which ordinarily would not be obtainable.

Dither

A receiver/driver feature which provides added protection to very low light level cameras by periodically panning a few degrees left and right automatically.

Lockouts

The ability of a switcher/controller system to restrict access of operations to certain system functions or features. The Allegiant system has two modes of lockouts. The first mode is based on operator priority level. This allows a higher priority level operator to lockout lower level operators from either viewing or controlling specific cameras. The second mode involves LTC 8059 Master Control Software setups which can:

- Restrict operators/keyboards from viewing/accessing any camera.
- Restrict operators/keyboards from controlling/accessing any pan/tilt.
- Restrict operators from using certain keyboards.
- Restrict operators/keyboards from accessing certain monitors.

Log-on, Log-off

A selectable feature of the Allegiant system which requires operators to enter a User number and an optional password into the keyboard prior to having access to system operations.

Matrix Switching

The ability of a switching system to display any camera on any monitor or the same camera on all monitors.

Phased Cameras

Properly integrated cameras which give a roll-free video display when switching from one camera to the next in a sequential switcher system. Phased cameras are the result of line-locked cameras being powered from the same AC power, externally synchronized, or vertically phased adjusted on cameras equipped with this option.

Pre-position

The ability to store the position of a pan/tilt and zoom lens so that the same desired scene can be later recalled automatically. With the Allegiant system, there can be multiple preset scenes stored for each pan/tilt camera. For each scene, the pan, tilt, zoom, and focus settings are stored.

SalvoSwitching

The ability of the Allegiant system to switch multiple video monitors as a synchronized group. Since multiple monitors switch together, the operator can view multiple scenes of a specific area or zone before switching to the next area.

Sequence

A series of camera scenes that can be preprogrammed to automatically switch. The Allegiant system can store up to 60 separate sequences, with each one capable of having a random camera order, individual camera dwell times, and SalvoSwitching steps.

Time Event

An Allegiant system feature (available with the LTC 8850 GUI Software or the LTC 8059 MCS) that enables various system functions to be periodically activated automatically. Event functions such as monitor message broadcasts, sequence and switching operations, receiver/driver actions, message printing, alarm settings, and execution of custom factory programming can be stored in the system memory to be executed at a pre-determined time. The task can be specified to begin on a specific year, month, day, and time, and can be programmed to repeat at intervals ranging from every five minutes up to a year.

Vertical Interval Switching

Vertical Interval switching is a method of switching video from camera to camera during the vertical blanking interval period of the video signal. This minimizes visual switching disturbances such as rolling, jitter, video flashes, etc. and eliminates frame information loss when used with VCR machines.

Appendix A Satellite Systems

A satellite system configuration is usually used for a medium to large distributed system, or to obtain extremely large matrix sizes configured more conventionally. Typically, a single Main control site can be used to view/control cameras located both locally and at various remote satellite sites. Since up to 256 satellite sites can be linked to a single Main control site, very large, distributed systems can be achieved. If the satellite systems are located at the same site as the Main system, the result is a large conventional-type system.

In a satellite configuration, the Main control site can view/control any camera in the entire system, but the remote satellite sites can only view/control cameras associated with their own site. Satellites may be configured to operate either independently or, with no local viewing/control capability.

It is also possible to configure satellite systems where each site can view/control cameras from anywhere in the system. For a two (2) site system, this is referred to as a dual master configuration. In the same manner, triple and quadruple master system configurations can also be configured. Cascaded satellite systems, where a Main site has a satellite which is a master to another satellite is another available scenario. In fact, it is possible to configure systems that include a mixture of any or all of the above scenarios.

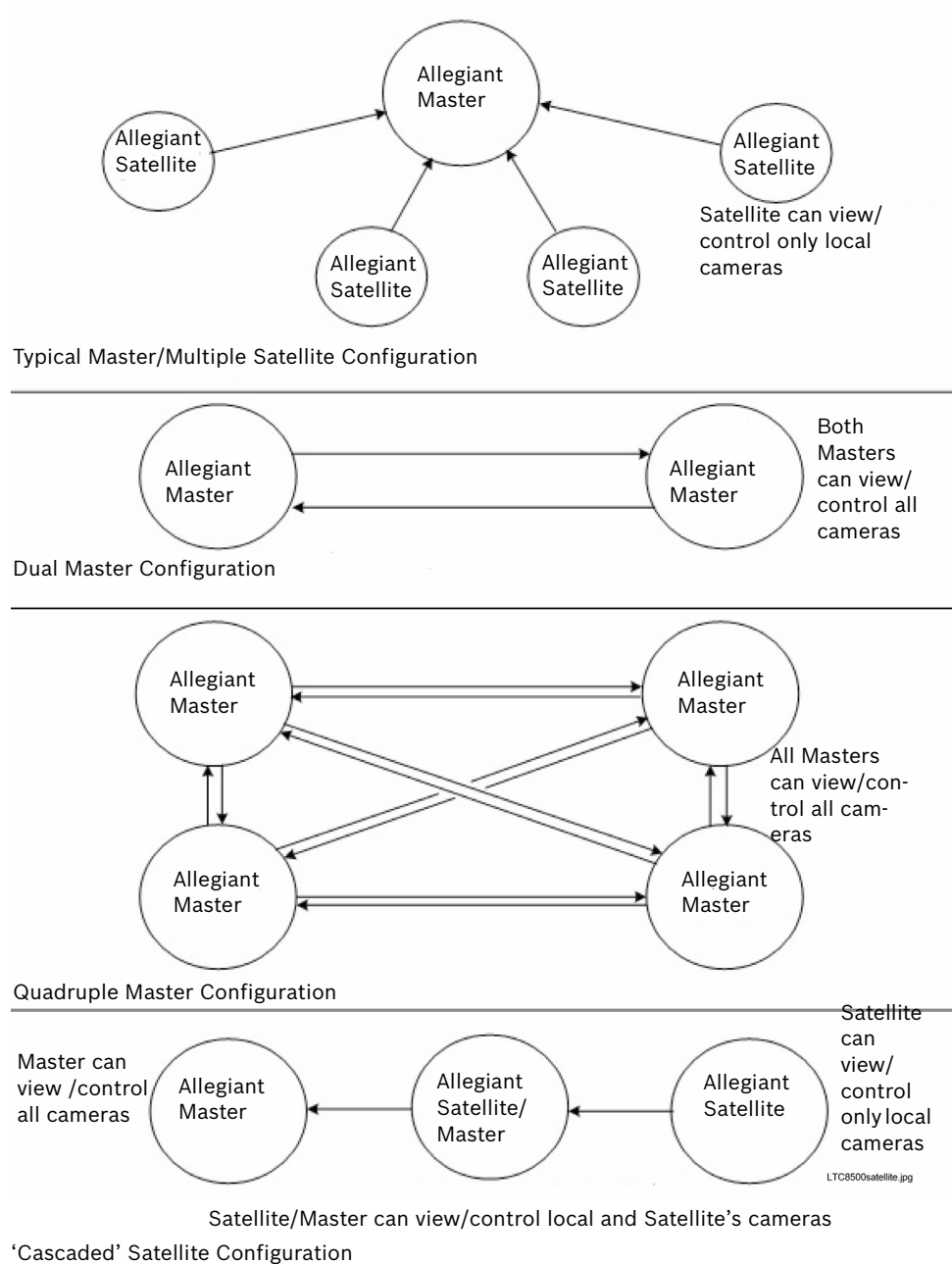

Figure 22: Possible Allegiant Satellite System Configurations

Any Allegiant Series switcher model (LTC 8100, LTC 8200, LTC 8300, LTC 8500, LTC 8600, LTC 8800, or LTC 8900) can be used as a main site or a satellite site unit. All products are standard models, and the only special requirement is to use either the optional LTC 8059/00 MCS or the optional LTC 8850/00 GUI Software package for initial programming of each Allegiant system.

An Allegiant biphasic control data line from the code distribution unit at the Main site must be provided to each satellite site. This data line carries all pan/tilt/zoom control commands, in addition to the switching commands generated by the Main site switcher. The control data line should be connected to a LTC 8780 Series Data Converter to provide address decoding functions for the satellite site. If operators at the satellite site are permitted to control pan/tilt/zoom-equipped cameras, a

LTC 8569 Series Code Merger must be installed at the satellite site. The Code Merger combines code generated by the main site and the satellite site, so both sites have control over pan/tilt/zoom-equipped cameras located at the satellite site. The LTC 8780 Series unit can then be connected to one of the data outputs of the LTC 8569 Series unit.

One or more monitor outputs from each satellite system are used as video trunk lines to link the remote sites to the Main site. The number of trunk lines from a satellite site determines the maximum number of cameras from that site that may be viewed simultaneously at the Main site. A satellite switcher model must be selected so that it provides the desired number of local monitor outputs plus the number of monitor outputs that will be used as trunk lines.

The Main site switcher must include sufficient camera inputs for local cameras plus trunk lines. The maximum physical number of camera inputs or monitor outputs used as trunk lines cannot exceed the capacity of the system. A single Main site switcher can control multiple satellite sites up to its video input limit. If full matrix switching is required at the Main site, the number of trunk lines from each satellite site must equal the number of monitors connected to the Main site switcher. Multiple independently controlled Main site systems can be combined to provide large numbers of monitor outputs at the Main site. System capacities are listed below:

System Type	Max. Camera Inputs	Max. Monitor Outputs	Max. No. of Satellite Sites
LTC 8100 Series	8	2	8
LTC 8200 Series	16	5	16
LTC 8300 Series	32	6	32
LTC 8500 Series	64	8	64
LTC 8600 Series	128	16	128
LTC 8800 Series	256	64	256
LTC 8900 Series	4096	512	256

Since Main site Allegiant Series switchers support access to a large quantity of remote satellite cameras, they provide additional logical camera numbers for identifying the location of the satellite camera inputs in the system. These logical camera numbers can also include titles which would appear on the Main site's monitors for any remote cameras. Since each camera (anywhere in the system) must have a unique camera number, logical camera numbers together with physical camera inputs make up the total system camera capacity. Thus, there is a trade-off between the total number of Main site cameras and the number of inputs used as trunk lines.

The more inputs used as trunk lines, the fewer there are for use as direct camera inputs.

Model No.	Maximum Number System Cameras*
LTC 8100 Series	264
LTC 8200 Series	272
LTC 8300 Series	288
LTC 8500 Series	320
LTC 8600 Series	1152
LTC 8800 Series	2304
LTC 8900 Series	6144

*Camera inputs at all sites, plus trunk lines.

The Main site system must be programmed via the MCS LTC 8059/00 or the LTC 8850/00 GUI to identify camera trunk line inputs as well as remote satellite cameras. All systems must be configured with no duplicate camera numbers anywhere in the system. The installer should verify that the camera numbers programmed into the Start-up Camera field of the Monitor table are suitable for viewing by respective operators. If there are Lockouts programmed into the system, specify-

ing a neutral camera would prevent the situation where a restricted camera could be switched to a restricted operator's monitor when their trunk line is stolen. For this feature to operate properly, the start-up camera numbers must be locally connected cameras or a local unused input (i.e., the raster generator will be displayed when called-up).

In addition, it is recommended to program Lockouts for all system keyboards so that they do not have access to unused monitor outputs. This prevents operators from inadvertently selecting a satellite camera on a non-existent monitor which will result in a trunk link becoming used up, possibly making less trunk lines available for valid selections.

Keyboard User Function 41 (See Chapter 15, "User Information," on page 56) offers additional programming options if a multi-level cascaded Allegiant satellite system configuration is being used.

Any alarm inputs to the Main site configured to activate satellite cameras operate normally except when limited by the number of available trunk lines. The software automatically determines trunk usage, depending on the priority level of operators currently viewing satellite cameras.

Alarm inputs applied at a satellite site will NOT activate alarm video at the Main site. If the application requires alarms located at a satellite to activate video at the Main site, the Main site's LTC 8540/00 Alarm Interface unit must be remotely located. Multiple LTC 8540/00 Alarm Interfaces may be remoted via the LTC 8713 alarm port expander accessory, located at the Main switcher site in LTC 8800 and LTC 8900 systems. Up to two (2) LTC 8540/00 alarm interfaces with a LTC 8713 alarm port expander can be used in a LTC 8600 system. One LTC 8540/00 can be used in LTC 8500 systems. Since the LTC 8100, LTC 8200, and LTC 8300 Series contain an integral alarm interface, the remote alarm interface application does not apply.

A unique time and date synchronizing feature provided in the Time Event table of the MCS or the GUI Software may be programmed into the Main site switcher. This permits periodic synchronizing of the time and date to all remote switchers in the system based on the Main site's clock.

A conceptual diagram of a satellite switching system is follows:

Conceptual Diagram of Allegiant Satellite Switching System

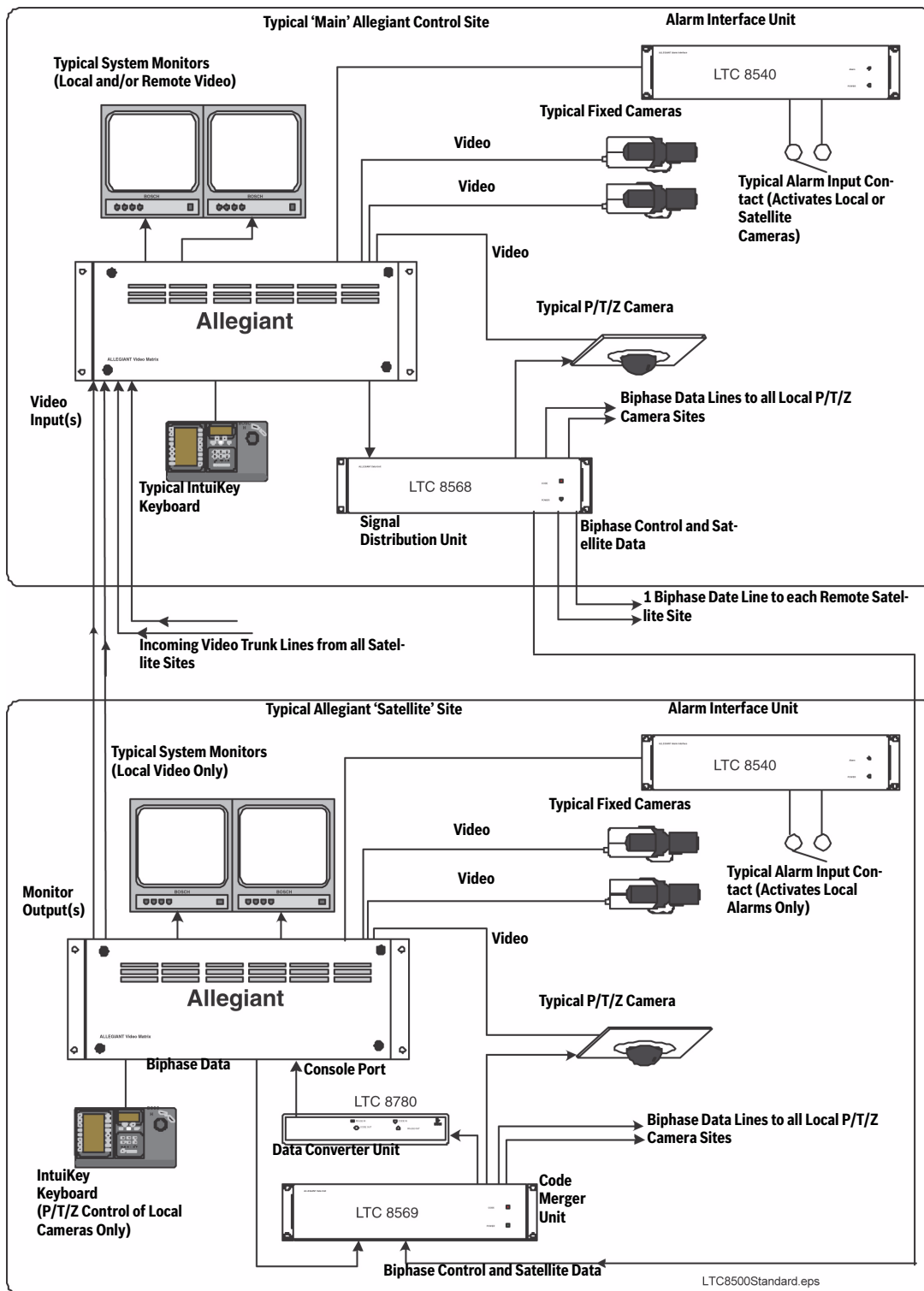

Figure 23: Conceptual Diagram of Allegiant Satellite Switching System

Conceptual Diagram of Dual Master Allegiant Satellite System

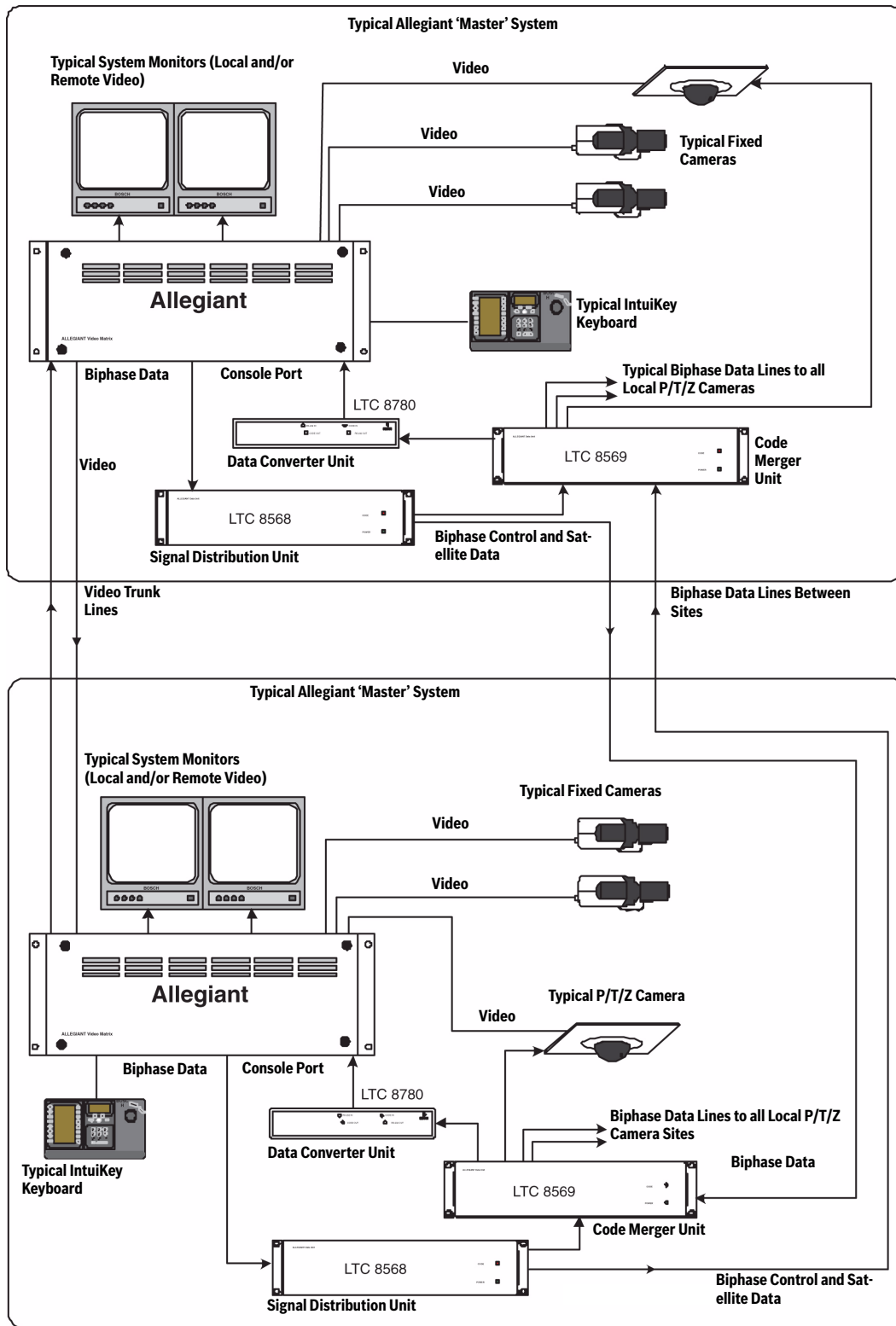

Figure 24: Conceptual Diagram of Dual Master Allegiant Satellite System

Conceptual Diagram of Cascaded Allegiant Satellite System

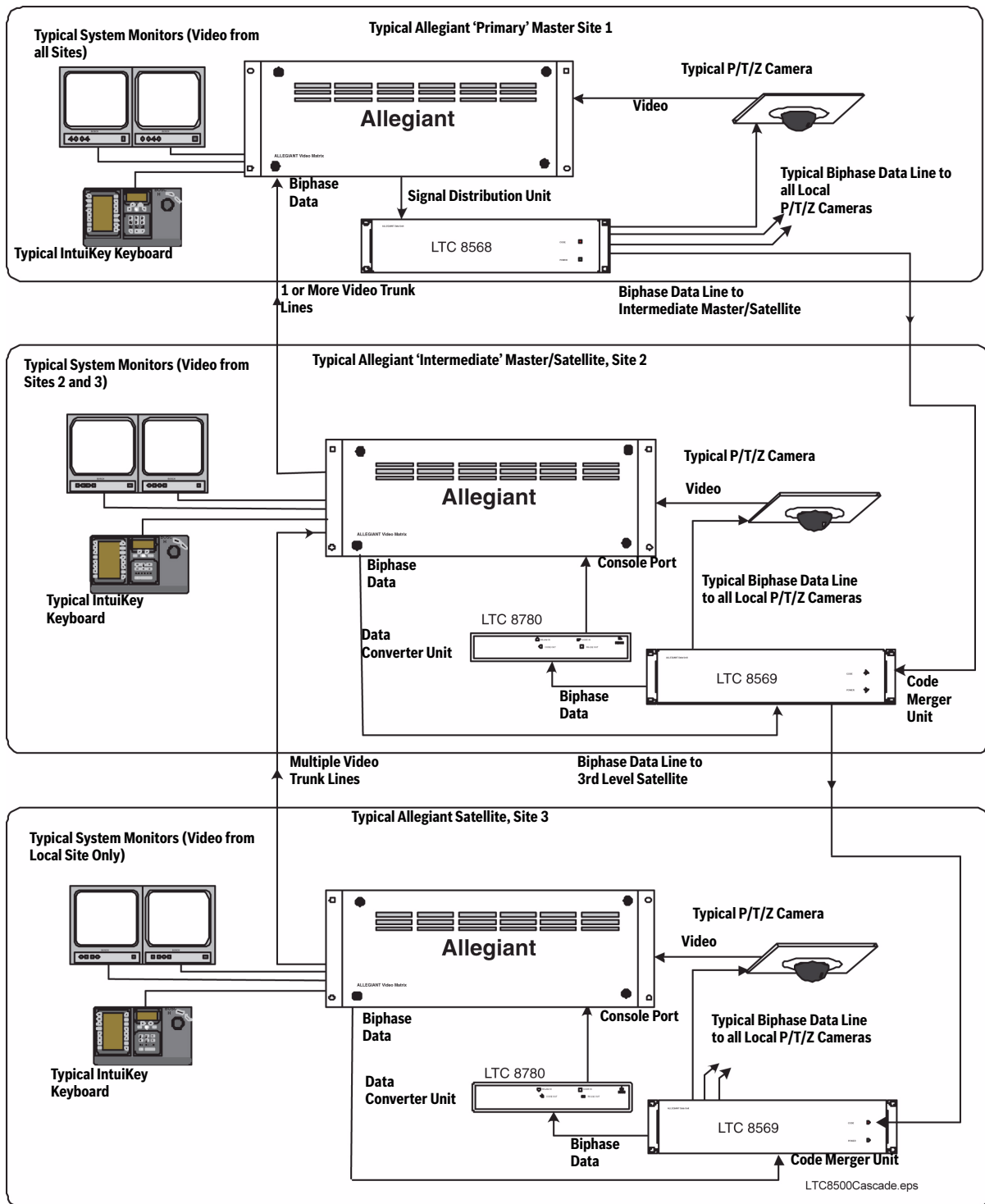

Figure 25: Conceptual Diagram of Cascaded Allegiant Satellite System

Appendix B Installation Checklists

A simplified guide for those who are already familiar with installing and programming Allegiant systems.

MAIN BAY HARDWARE INSTALLATION	
	Unpack equipment and verify that items have been received without carrier damage.
	Install power supply (do not turn ON) and CPU module.
	If applicable, install bay into EIA 19-inch rack (remember to remove rubber bumper foot pads).
	Install video input module(s) following proper termination procedures. Install video output module(s).
	Connect camera inputs and monitor outputs to appropriate connections on equipment bay(s).
	Connect system keyboards, any alarm interface unit(s), and any signal distribution unit to main bay.
	Set CPU DIP switches to activate desired features.
	Apply main AC power to equipment.
	Verify system is operating properly then begin appropriate programming.
PROGRAMMING VIA SYSTEM KEYBOARD	
	Enter system time (User Function 7) and date (User Function 8). Enter Camera ID titles (User Function 9), and if desired, adjust monitor overlay displays (User Function 4, 5, & 6 or 24, 25 & 26).
	Enter desired Sequences.
	Configure and test alarm response mode.
SATELLITE CONFIGURATION HARDWARE INSTALLATION	
Main Site:	
	Install main Allegiant bay and appropriate accessory products accordingly. Verify biphasic control code line is run to each satellite site.
	Attach trunk line inputs, local camera inputs, and monitor outputs to main Allegiant bay. Apply main AC power to equipment.
	Program Camera ID table using LTC 8059 Master Control Software package.
	Switch all unused monitor outputs located at main site to display a 'local' camera input.
Satellite Site(s):	
	Install satellite switcher and appropriate accessory products accordingly.
	Connect biphasic code line to LTC 8780 Data Converter unit and configure according to desired satellite address and switcher's baud rate.
	If necessary, program satellite switcher for desired camera titles and any other related requirements.

Appendix C Quick Reference Cable Interconnections

C.1 Main Bay Video

COAX-All video input and output connections to the Allegiant system should be made using a good grade of RG59U, RG6, or RG11U coaxial cable using BNC connectors. The following guidelines should be used to insure selection of the proper cable type:

1. Center conductor of copper, not copper weld or steel. Use stranded wire where there will be cable movement as with pan/tilts, elevators, etc.
2. Copper braided shield at 93% coverage or better.
3. Cable impedance of 75 ohms.
4. Select cable based on target of no more than 15 ohms of center conductor resistance. A typical value for RG59U is 15 ohms per 300 m (1000 ft), therefore maximum cable run should be no more than 300 m (1000 ft). RG11U/RG6 is typically rated for 6 ohms per 300 m (1000 ft) which permits runs up to 760 m (2500 ft).
5. Use video amplifiers to extend cable distances beyond maximum limitations listed above.

C.2 Keyboards

- The keyboard comes supplied with 3 m (10 ft) of 6 conductor phone type cable with RJ-11 connectors. The cable plugs directly into the rear of the system's main bay on one end and into the back of the keyboard on the other end. Both data and power for the keyboard travel over this cable.
- An optional 30 m (100 ft) cable is also available.
- An optional kit which permits the keyboard to be extended beyond 30 m (100 ft) is available and uses customer supplied shielded twisted pair. The kit consists of two "breakout" boxes which convert from the phone type cables to the shielded twisted pair and also provide for local keyboard power. Maximum distance using 24 gauge wire (Belden 9841 or equivalent) is typically 1.5 km (5000 ft).

C.3 Alarm Interface Unit

CONNECTION TO MAIN BAY

The Alarm unit is supplied with a 3 m long (10 ft) multiconductor cable with 9-pin D-type connectors. Power to the Alarm unit is provided by the Allegiant's main bay using the supplied cable. There are provisions to remote the bay which would then require local 12 VAC power and a minimal 3 wire RS-232 communication link.

ALARM INPUTS

The alarm inputs can be dry contact closures or logic levels. Connection to the Alarm unit is made to removable screw type terminal blocks and the use of simple twisted pair wire is acceptable.

C.4 Signal Distribution Unit

CONNECTION TO MAIN BAY

The Distribution unit is supplied with a 3 m long (10 ft) multiconductor cable with 9-pin D-type connectors. Power to the unit is provided by the Allegiant's main bay using the supplied cable. The cable should not be extended so it is recommended that the unit be located close to the main bay.

DISTRIBUTION OUTPUTS

Only shielded twisted pair wire should be used between the Distribution unit and the camera site receiver/drivers. Connection to the Distribution unit is made to removable screw terminal type blocks. Each output is rated to handle up to eight receiver/driver loads as in a daisy chain configuration to a maximum of 1.5 km (5000 ft) using a 18 gauge wire (Belden 8760 or equivalent).

C.5 Receiver/Drivers

CODE INPUT

The code input is supplied by the shielded twisted pair cable from the Signal Distribution unit. This is connected to a removable screw terminal type block which has provisions for "looping" the code cable to another receiver/driver.

OUTPUT CONNECTIONS

All pan/tilt and lens connections will require multiconductor cable. Refer to the appropriate specification sheet for cable gage, number of conductors required, and maximum distances allowable. The lens cables and any pre-position cables should be kept shielded from other signal wires to minimize interference.

Appendix D Main Bay Rear Panel Connector Pin-outs

Console Port RS-232 Pin-outs

Pin #	Designation
1	CHASSIS GND
2	Rx
3	Tx
4	CTS
5	RTS
6	NO CONNECTION
7	DATA GND
8	NO CONNECTION
9	NO CONNECTION

Alarm Port RS-232 Pin-outs

Pin #	Designation
1	RTS
2	Tx
3	CHASSIS GND
4	DATA GND
5	DATA GND
6	Rx
7	CTS
8	12 VAC
9	12 VAC

Keyboard RS-485 Ports

Pin #	Designation
1	12 VAC
2	GND
3	-DATA
4	+DATA
5	GND
6	12 VAC

Printer Port RS-232 Pin-outs

Pin #	Designation
1	CHASSIS GND
2	Rx
3	Tx
4	CTS
5	RTS
6	NO CONNECTION
7	DATA GND
8	NO CONNECTION
9	NO CONNECTION

Code Port Pin-outs

Pin #	Designation
1	+DATA
2	-DATA
3	GND
4	GND
5	GND
6	NO CONNECTION
7	NO CONNECTION
8	12 VAC
9	12 VAC

COMM PORT 1 And COMM PORT 2

(Not Applicable To All Systems)

Pin #	Designation
1	CHASSIS GND
2	+TXD
3	-TXD
4	+RXD
5	-RXD
6	GND
7	GND
8	GND
9	GND

- The LTC 8506/00 cable (used to connect the Allegiant's console port to an external PC) uses the following pin-outs:

9-Pin Male (Console)	Allegiant Designation	9-Pin Female (PC Side)
1	Chassis GND	None
2	Receive	Data 3
3	Transmit	Data 2
4	CTS	1
5	RTS	8
6	No Connection	None
7	Data GND	5
8	No connection	None
9	No connection	None

(pins 4 & 6 jumpered)
(pins 1 & 7 jumpered)

- For reference, a cable to connect the Allegiant's printer port to an external serial printer would use the following pin-outs:

9-Pin Male Printer (Printer)	Allegiant Designation	25-Pin Female (Printer Side)
1	Chassis GND	1
2	Receive Data	2
3	Transmit Data	3
4	CTS	4,8
5	RTS	5
6	No Connection	None
7	Data GND	7
8	No connection	None
9	No connection	None

(pins 6 & 20 jumpered)

Americas

Bosch Security Systems
130 Perinton Parkway
Fairport, New York, 14450 USA
Phone: +1 888-289-0096
+1 585-223-9180
security.sales@us.bosch.com
<http://www.boschsecurity.us>

Europe, Middle East, Africa

Bosch Security Systems B.V.
P.O. Box 80002
5600 JB Eindhoven, The Netherlands
Phone: + 31 (0) 40 2577 284
Fax: +31 (0) 40 2577 330
RMADesk.STService@nl.bosch.com
<http://www.boschsecurity.com>

Asia-Pacific

Bosch Security Systems Pte Ltd
38C Jalan Pemimpin
Singapore 577180
Phone: +86 (0) 756 7633117
Fax: +86 (0) 756 7631710
customer.service@cn.bosch.com
<http://www.boschsecurity.com>

- 2009 Bosch Security Systems, Inc.
F.01U.127.393 | Updated March 17, 2009 | Data subject to change without notice

**BOSCH**